

---

# Appendix A

---

# SAMPLE HOMEWORK

*SAMPLE  
HOMEWORK*

Name: \_\_\_\_\_

B

O

M

O

B

O

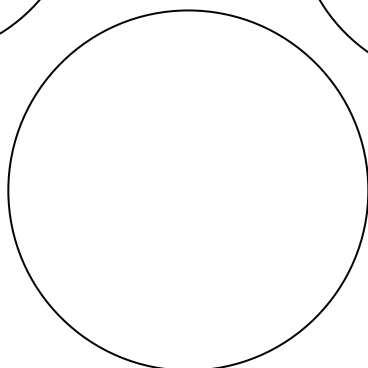
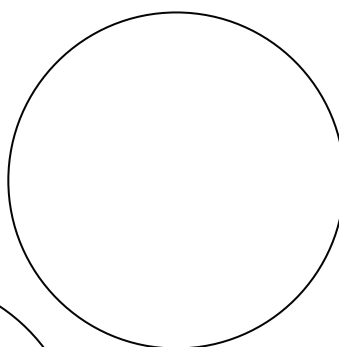
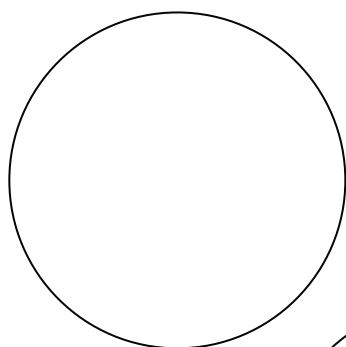

Name: \_\_\_\_\_

M

B

O

O

B

M

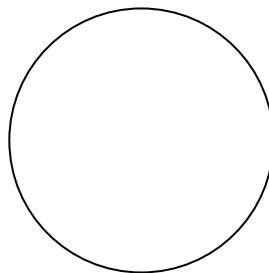
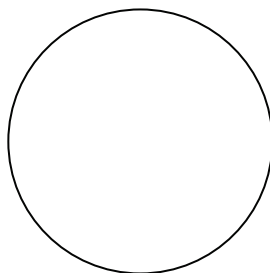
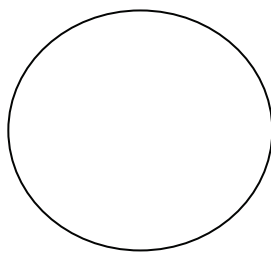
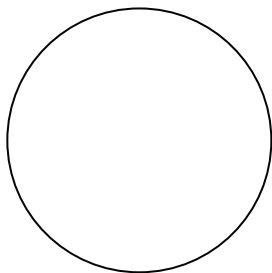

Name: \_\_\_\_\_

M

B

O

O

S

M

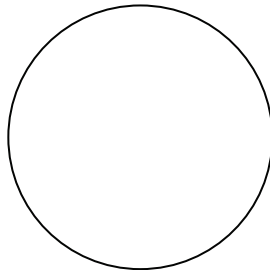
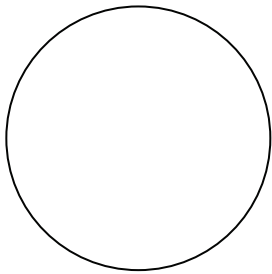
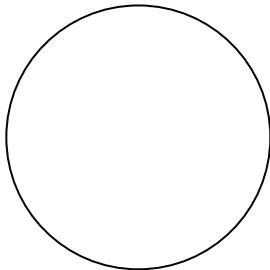
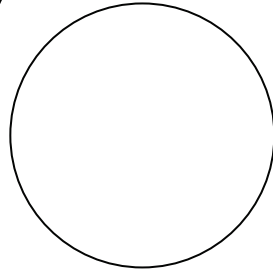
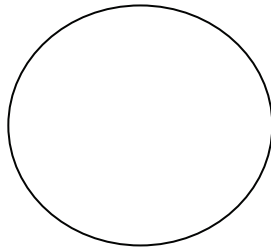
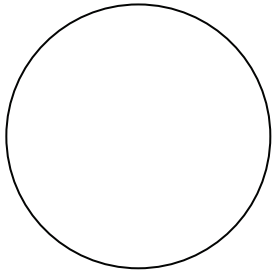

Name: \_\_\_\_\_

M

B

O

O

S

M

S

M

O

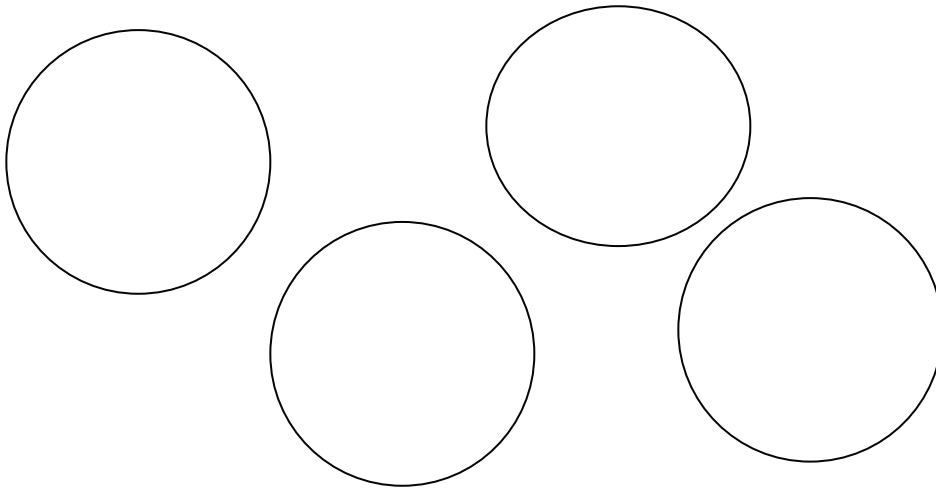

Name: \_\_\_\_\_

A

B

O

B

S

M

S

M

A

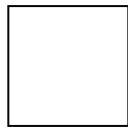
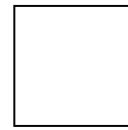
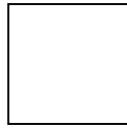
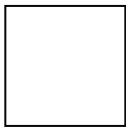

Name: \_\_\_\_\_

S

B

A

O

S

M

A

B

O

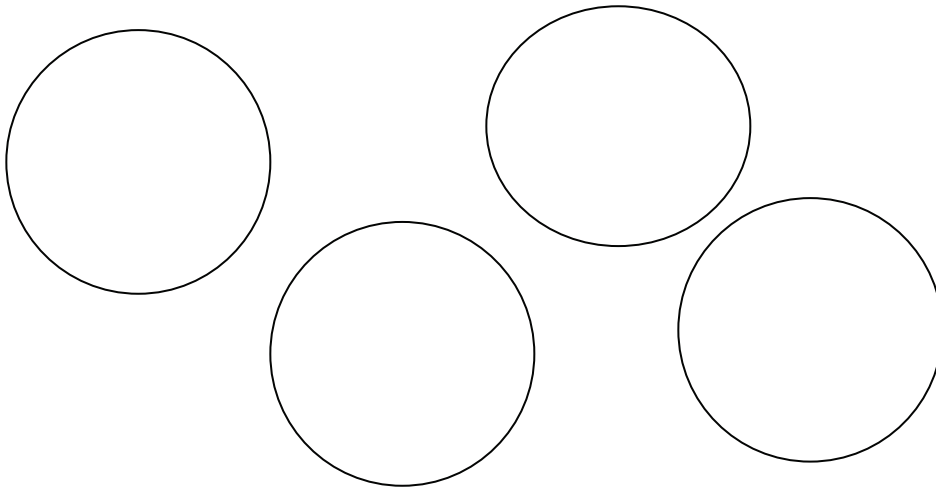

Name: \_\_\_\_\_ Date: \_\_\_\_\_

O S M M

A M M S

M A O S

B B B M



Name: \_\_\_\_\_ Date: \_\_\_\_\_

O S M B

B A A B

S O B A

A M A M

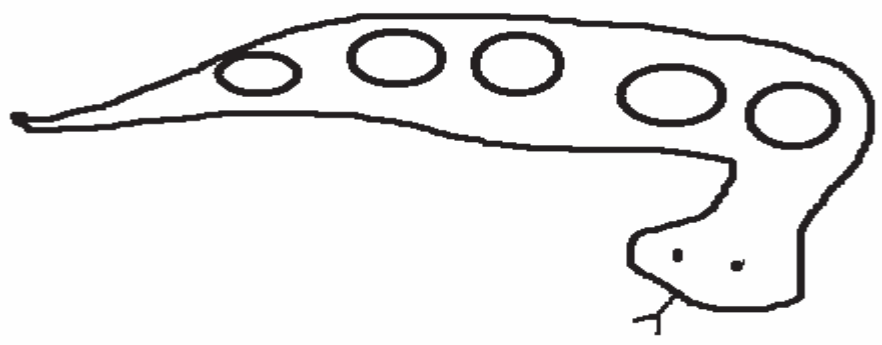

Name: \_\_\_\_\_ Date: \_\_\_\_\_

A B S O

M M S M

B O B S

A B A T

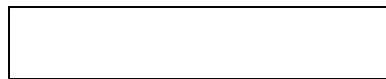
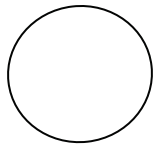
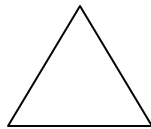
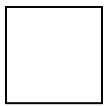
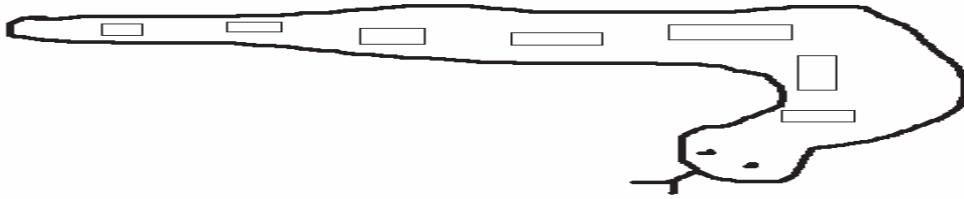

Name: \_\_\_\_\_ Date: \_\_\_\_\_

O S M T

B A A B

S A O B

M A M A

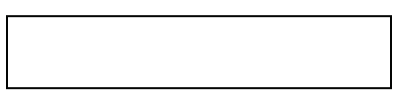
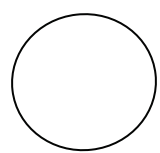
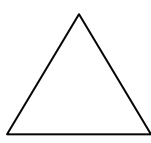

Name: \_\_\_\_\_ Date: \_\_\_\_\_

O            B            A            S  
M            S            A            A  
A            A            T            A  
B            A            B            A  
S            O            B            A

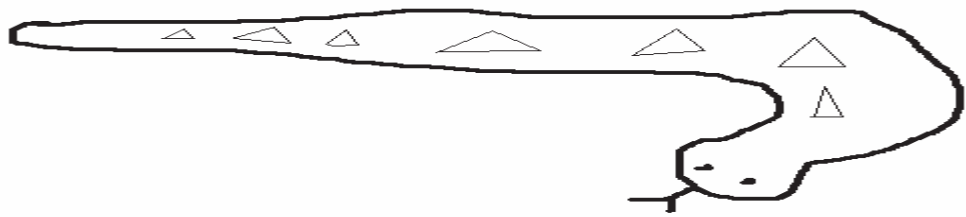
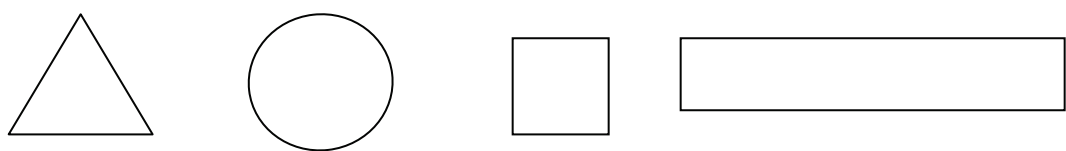

Name: \_\_\_\_\_ Date: \_\_\_\_\_

O S M T  
A B S O  
M A M A  
A B A A

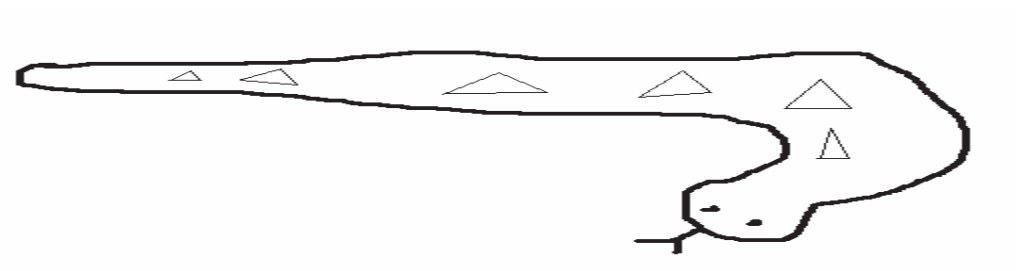
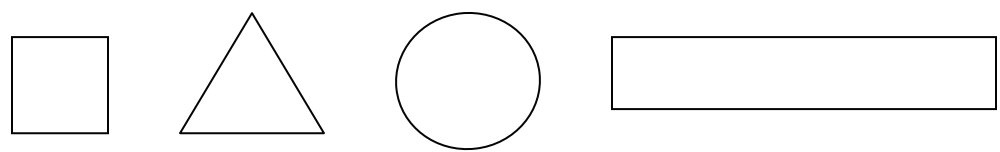

Name: \_\_\_\_\_ Date: \_\_\_\_\_

S A M O

A B T S

T A M B

T E E A

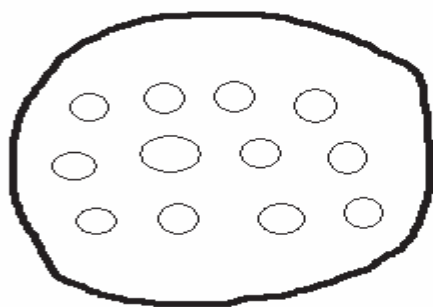

Name: \_\_\_\_\_ Date: \_\_\_\_\_

M      A      A      O

M      B      A      A

S      M      O      A

A      A      S      T

M      B      B      B

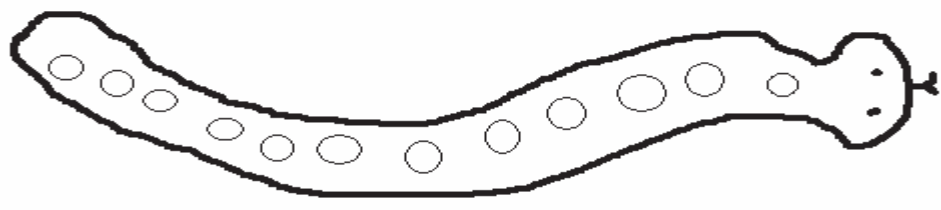

Name: \_\_\_\_\_ Date: \_\_\_\_\_

|   |   |   |   |
|---|---|---|---|
| S | A | M | O |
| B | A | A | B |
| T | S | T | A |
| B | E | C | C |
| E | E | T | S |

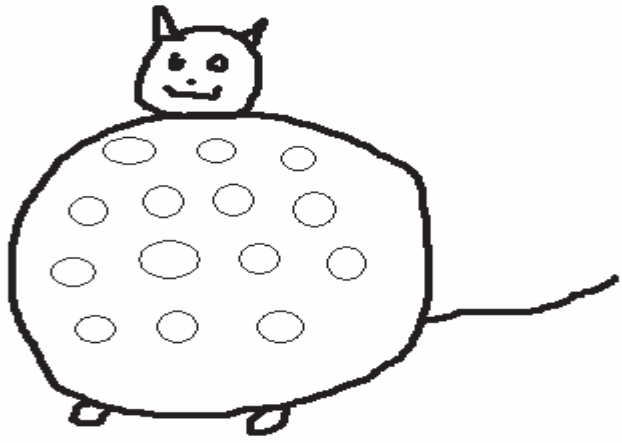



Name: \_\_\_\_\_ Date: \_\_\_\_\_

S A M T O

A A C C B

T S M B A

C C C E E

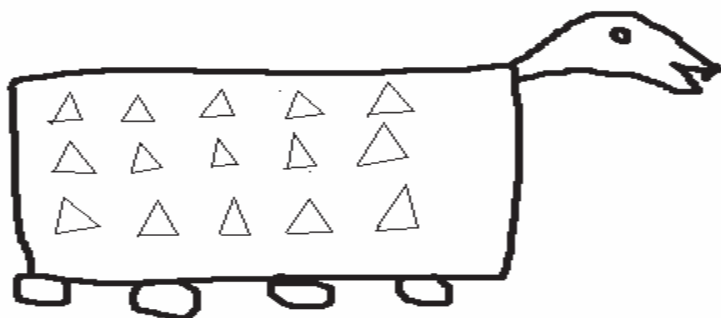

Name: \_\_\_\_\_ Date: \_\_\_\_\_

|   |   |   |   |
|---|---|---|---|
| S | A | M | T |
| C | B | O | C |
| C | S | A | A |
| E | C | E | E |
| C | T | A | B |

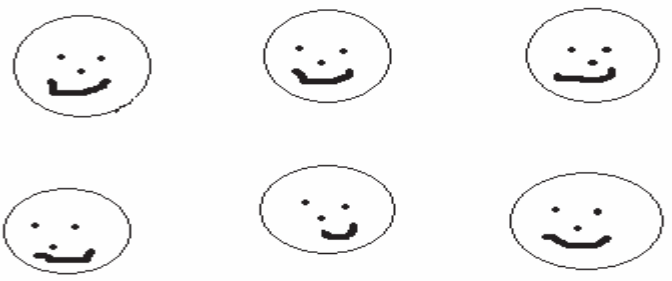

Name: \_\_\_\_\_ Date: \_\_\_\_\_

|   |   |   |   |
|---|---|---|---|
| S | A | M | B |
| E | C | T | O |
| D | C | B | A |
| E | D | D | C |
| T | O | D | C |



Count the tentacles (arms)

Name: \_\_\_\_\_ Date: \_\_\_\_\_

S            A            M            O            B  
E            T            A            B            O  
D            C            E            C            A  
B            D            T            O            M  
a            a            a            a            a

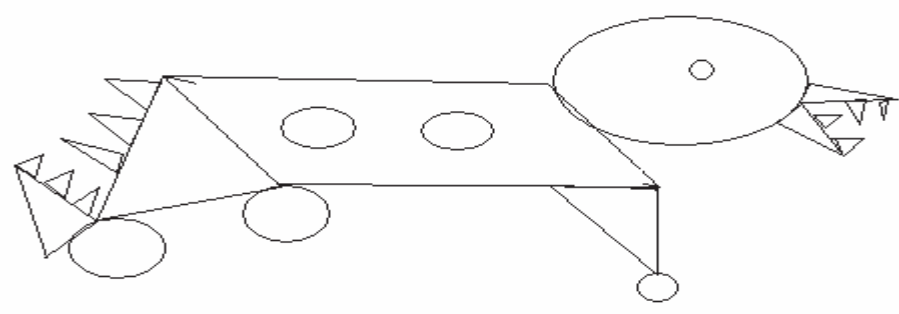

See any triangles? Point to them. Circles? Optional: tilted rectangle making up most of body is “sort of a rectangle,” but tilted, so it is not really a rectangle (Highly optional: it is a “parallelogram”)

Name: \_\_\_\_\_ Date: \_\_\_\_\_

S            A            M            O

A            B            C            D

E            M            C            T            W

W            R            A            E

C            e            a            e

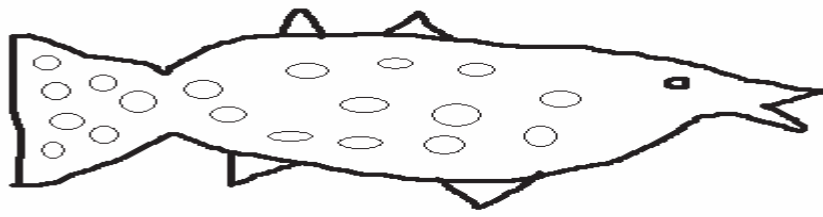

Some of the circles are squished. "Ovals." Count them all. See any triangles?

Name: \_\_\_\_\_ Date: \_\_\_\_\_

S A M a B  
R W T e C  
E B D M A  
R a e P R

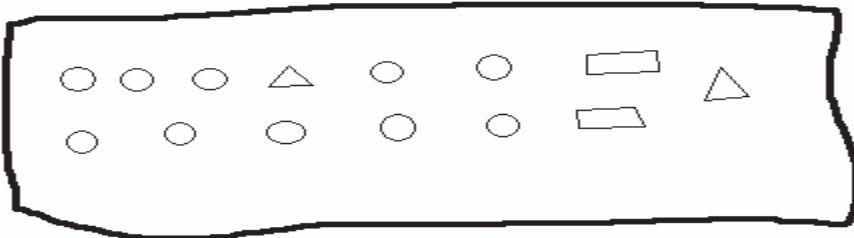

What are the different shapes? Count each shape.

Name: \_\_\_\_\_ Date: \_\_\_\_\_

S            A            M            B  
T            a            R            E            C  
C            P            a            A  
D            E            W            T  
a            R            R            B

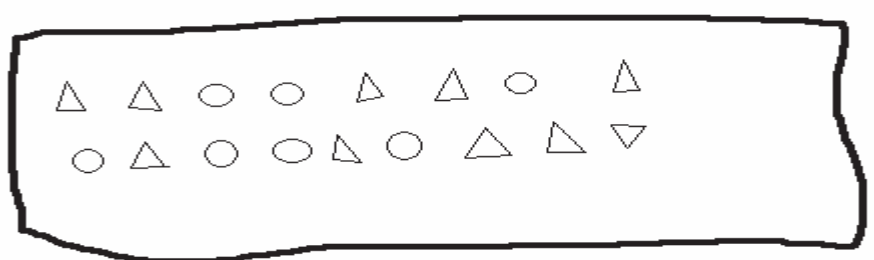

Count the triangles. Now count the circles.

Name: \_\_\_\_\_ Date: \_\_\_\_\_

S A M B C

O W R C E

a T R C e

D a R a

e E a C

blast off



Name: \_\_\_\_\_ Date: \_\_\_\_\_

S            A            M            B            e

a            E            C            R            T

W            e            D            E            M

O            P            a            e            e

1            2            3

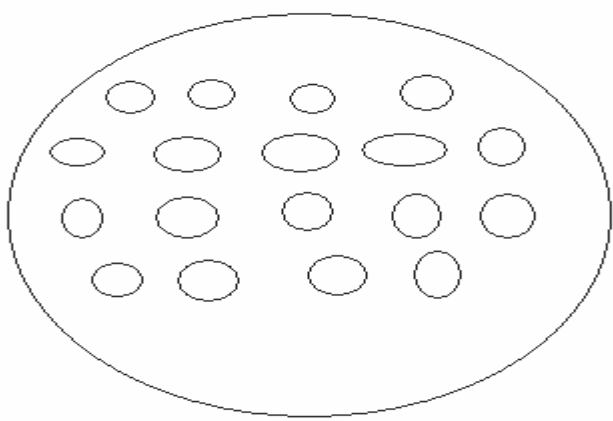

Are some of these not very good circles? "Ovals." Count them all – circles and ovals.

blast off

Name: \_\_\_\_\_ Date: \_\_\_\_\_

|   |   |   |   |
|---|---|---|---|
| S | A | M | D |
| B | C | E | P |
| a | O | N | W |
| e | L | R | T |
| 1 | 2 | 3 |   |

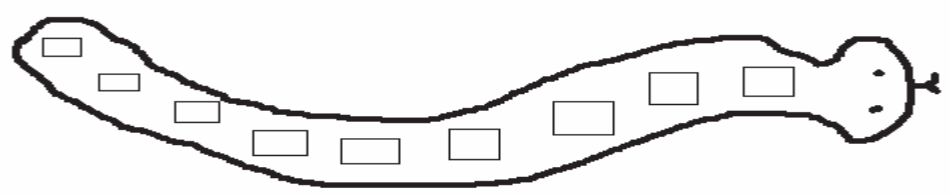

Name: \_\_\_\_\_ Date: \_\_\_\_\_

S            A            M            B  
R            a            E            C  
D            T            e            O  
L            P            M            R  
N            W            i            A  
1            2            3

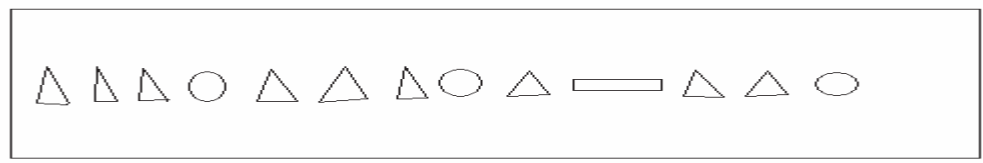

Count the triangles. What are the other shapes?

blast off

Name: \_\_\_\_\_ Date: \_\_\_\_\_

S            A            M            a            e

C            D            B            L

W            R            a            P

E            e            L            N

T            e            a            B

1            2            3

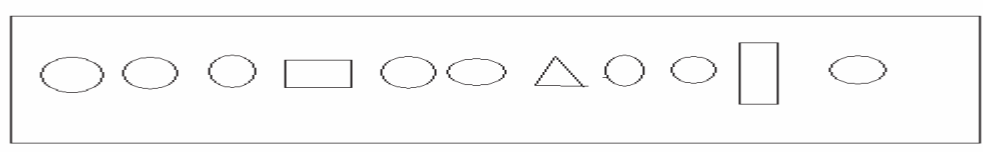

Count the circles. What are the other shapes? (note – there are no squares, just circles, triangles and rectangles)

blast off

Name: \_\_\_\_\_ Date: \_\_\_\_\_

S            A            M            B  
N            O            C            a  
e            P            D            E  
i            L            W            R  
T            e            a            i  
1            3            2

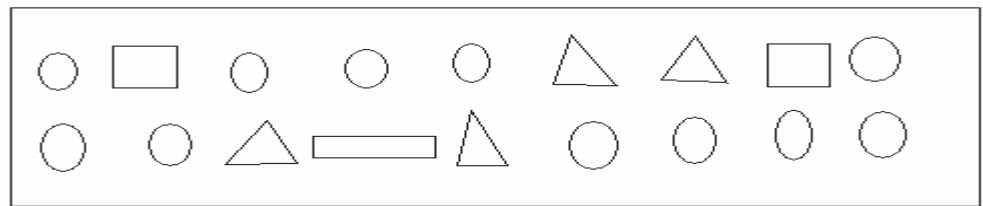

Count the circles. Rectangles. Triangles.

blast off

Name: \_\_\_\_\_ Date: \_\_\_\_\_

S            A            M            C

B            a            i            e

O            U            W            N

P            R            T            E

e            a            i            o

D            B            P            R

3            1            2



How many circles in each section? How many in all? Are some of the circles a little weird?

blast off

Name: \_\_\_\_\_ Date: \_\_\_\_\_

S            A            M            e  
B            D            P            a  
R            T            C            L  
E            i            W            O  
N            a            e            i  
3            2            1

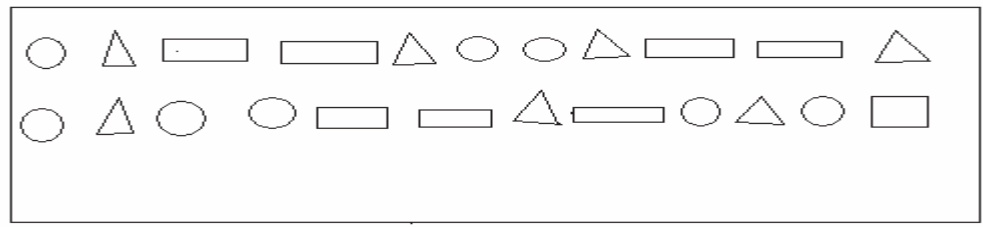

How many circles? Rectangles? Triangles? How many shapes in all?

blast off

Name: \_\_\_\_\_ Date: \_\_\_\_\_

S            A            M            a            R  
O            B            D            E            C  
a            L            N            I            P  
T            V            W            Y            e

Vowels: \_\_\_\_\_

3            2            1

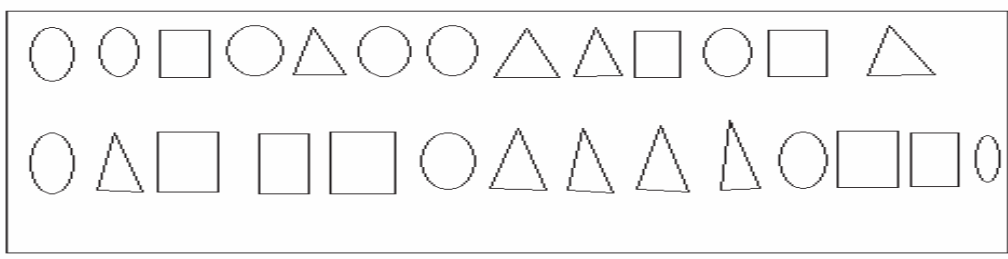

How many circles? Rectangles? Triangles? How many shapes in all?

blast off



Name: \_\_\_\_\_  
\_\_\_\_\_ Date: \_\_\_\_\_

S            A            M            R            B

a            e            i            o            P

C            D            E            L            N

T            W            a            e            L

1            2            3            4

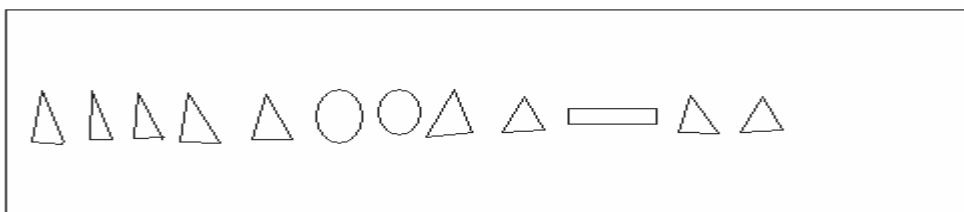

**Vowels:**

blast off

Name: \_\_\_\_\_ Date: \_\_\_\_\_

|   |   |   |   |   |
|---|---|---|---|---|
| S | A | M | D | D |
| L | P | a | R |   |
| B | C | e | L |   |
| i | a | E | c |   |
| N | O | T | W |   |
| 1 | 3 | 4 | 2 |   |

VOWELS: \_\_\_\_\_

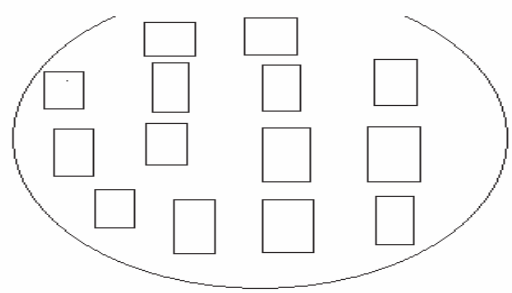

blast off

Name: \_\_\_\_\_ Age: \_\_\_\_\_

S a m e L i

c a t w u R

|           |           |   |   |   |
|-----------|-----------|---|---|---|
| 1         | 2         | S | a | m |
| <u>+1</u> | <u>+1</u> |   |   |   |
| 2         | 3         |   |   |   |

VOWELS: \_\_\_\_\_

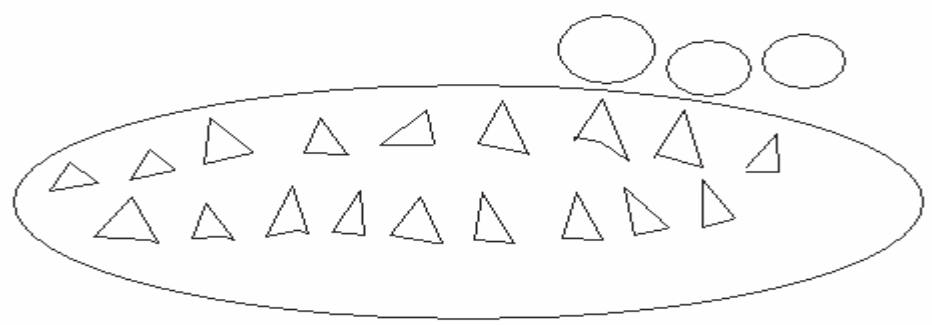

blast off

Name: \_\_\_\_\_ Date: \_\_\_\_\_

S a m B L

R e o t i u

C E D N P A

W a o i e u

3 4 1 2

Vowels: \_\_\_\_\_

Cat

blast off

Name: \_\_\_\_\_ Date: \_\_\_\_\_

S a m B e i

D c E L o A

P R t s u N

W m a e i

3 5 2 1 4

cat 1  
+1

Vowels: \_\_\_\_\_

blast off

Name: \_\_\_\_\_ Date: \_\_\_\_\_

S a m o B D

R e a i c E

H I L N P S

T u v w y i

6 2 1 4 5 3

Vowels: \_\_\_\_\_

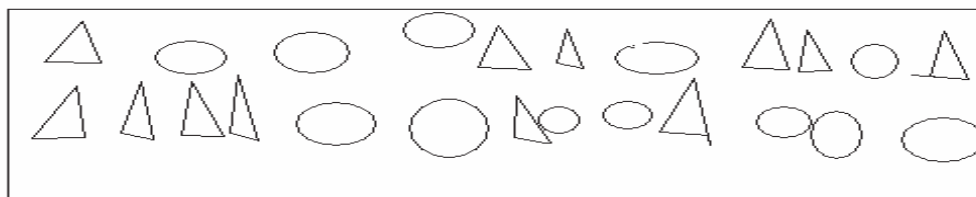

blast off

Name: \_\_\_\_\_ Date: \_\_\_\_\_

S a m i p R

t a e c o u

B W R D Y

E a H L N

3 1 4 2 5 11

Vowels: \_\_\_\_\_

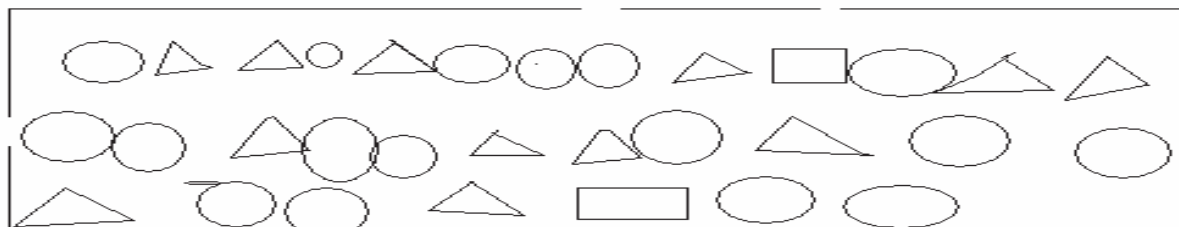

blast off

Name: \_\_\_\_\_ Date: \_\_\_\_\_

S a m A B C D

B E B e o B U

L B P B R T B

i b c D B H W

B N r B a e

1 3 5 8 4 2

Vowels: \_\_\_\_\_

blast off



Name: \_\_\_\_\_ Date: \_\_\_\_\_

e L B c D H

i a w s A M

N R P E G o

T u x y r

2 1 0 3 4 5

6 8 7 4 6 7

Vowels: \_\_\_\_\_

cat fat 2  
+ 2

blast off

Name: \_\_\_\_\_ Date: \_\_\_\_\_

a c L B S A T

M R W u r i E

D E U F G W H

N P o X

1 6 2 3 5 8 4

2 cat hat  
+1

Vowels: \_\_\_\_\_

blast off

Name: \_\_\_\_\_ Age: \_\_\_\_\_

a i B e s o u

c y w D e x

H L P N M r

R T t S

5 8 2 4 3 1

Sat 
$$\begin{array}{r} 2 \\ +3 \\ \hline \end{array}$$

VOWELS: \_\_\_\_\_

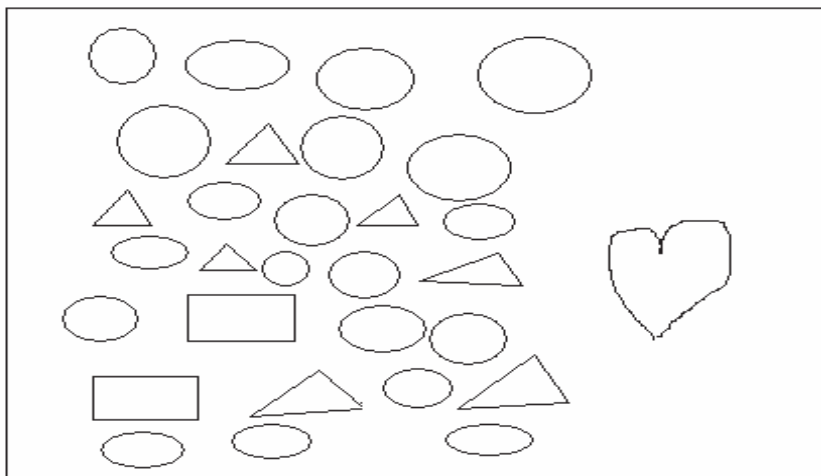

blast off

Name: \_\_\_\_\_ Date: \_\_\_\_\_

S a m i p R

t a e c o u

B W R D Y

E a H L N

3 1 4 2 5 11

Vowels: \_\_\_\_\_

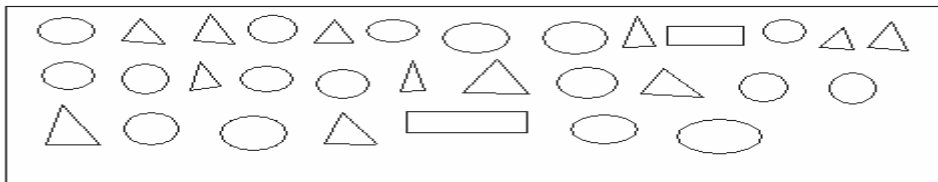

blast off

Name: \_\_\_\_\_ Date: \_\_\_\_\_

S a m A B C D

B E B e o B u

L B P B R T B

i B C D B H W

B N r B a e

1 3 5 8 4 2

Vowels: \_\_\_\_\_

blast off

Name: \_\_\_\_\_ Date: \_\_\_\_\_

e L B C D H

i a W S A M

N R P E G O

T U X y r

2 1 0 3 4 5

6 8 7 4 6 7

Vowels: \_\_\_\_\_

C a t F a t 2  
+2

blast off

Name: \_\_\_\_\_ Date: \_\_\_\_\_

a c L B S A T

M R W u r i E

D E U F G W H

N P O X

1 6 2 3 5 8 4

2

+1 c a t h a t

Vowels: \_\_\_\_\_

blast off

Name: \_\_\_\_\_ Date: \_\_\_\_\_

a i B e s o u

c y w D E X

H L P N M r

R T t s

5 8 2 4 3 1 2 + 3 =

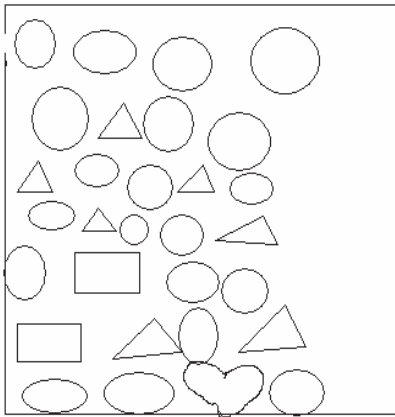

Sat

Vowels: \_\_\_\_\_

blast off



Name: \_\_\_\_\_ Date \_\_\_\_\_

U W L R a T H

i o S e P B E

C M D A y r g G

5 8 6 3 1 4 2

2 3 2 2  
+1 +1 +2 +3

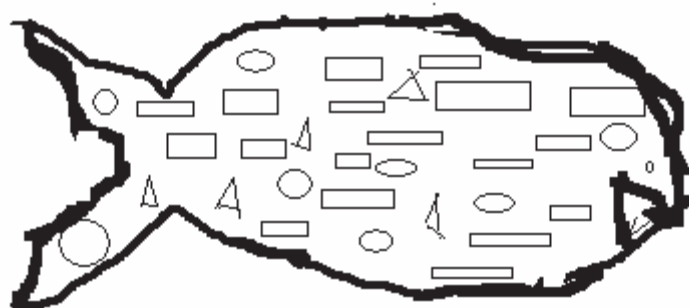

Vowels \_\_\_\_\_ Blast Off!

Name: \_\_\_\_\_ Date: \_\_\_\_\_

W x a c y D e

F G H P R i L

T S M o N u v

5 2 1 8 3 4

cat fat  $1+3=$

$2+2=$   $3+2=$

Vowels: \_\_\_\_\_

blast off

Name: \_\_\_\_\_ Date: \_\_\_\_\_

a L X W B Y

C D S e T F

u G V H R E

r i p M o N

5 8 3 2 1 4 0 6

6 6 6 6 \_ \_ \_ 6 9

1 2 Fat Cat  
+1 +2

Vowels: \_\_\_\_\_

blast off

Name: \_\_\_\_\_ Date: \_\_\_\_\_

B x w N a o L p

Q R c A T S M

D e u E V F G

H i

3 5 6 6 6 2 2 6 2 6

8 4 1 0 6 2 2 6 2 6

|           |           |     |
|-----------|-----------|-----|
| 1         | 2         | Dog |
| <u>+3</u> | <u>+0</u> | Cat |

Vowels: \_\_\_\_\_

blast off

Name: \_\_\_\_\_ Date: \_\_\_\_\_

X L e u v F

D F G H i F

F O G L Q r

r F u F V r

2 6 8 6 4 6 6 10

1 2 5 3  
+4 +3 +5 -1

SAT

Vowels: \_\_\_\_\_

Blast off

Name: \_\_\_\_\_ Date: \_\_\_\_\_

r y L x G H a B

e r F i Q v x F

F r v r F r R v

8 6 2 6 3 1 6 4 0

|           |           |           |           |           |
|-----------|-----------|-----------|-----------|-----------|
| 1         | 2         | 2         | 3         | 3         |
| <u>+2</u> | <u>+2</u> | <u>+3</u> | <u>-1</u> | <u>-2</u> |

CAT HAT

Vowels: \_\_\_\_\_  
blast off

Name: \_\_\_\_\_ Date: \_\_\_\_\_

a c B y w D G e

E S U T F H P

Q i r L R m

O N r F v r v

3 6 8 4 2 6 1 5

1 3 2 4  
+2 +1 +2 -1

Vowels: \_\_\_\_\_

blast off

Name: \_\_\_\_\_ Date: \_\_\_\_\_

S a m A Y W B

D X C F U E V G T

R H S i r L p N T

Q o e T

4 3 6 0 5 2 1 7 10

2 3 4 5  
+2 +2 +1 -2

Vowels: \_\_\_\_\_

blast off



Name: \_\_\_\_\_ Date: \_\_\_\_\_

I r t N F G H a e T

B D L p Q R u V X

6 1 4 5 3 6 2 8 7

Fat Cat

|           |           |           |           |           |
|-----------|-----------|-----------|-----------|-----------|
| 2         | 3         | 4         | 4         | 4         |
| <u>+2</u> | <u>+1</u> | <u>+2</u> | <u>-1</u> | <u>-2</u> |

Vowels: \_\_\_\_\_

blast off

Name: \_\_\_\_\_ Date: \_\_\_\_\_

S a m o p e i

r v L u B c x

W N x c D E H

G F A t s Q R y

8 6 4 2 1 3 5 7 9

2 3 5 4  
+2 +1 -3 -1

Vowels: \_\_\_\_\_

Fat Cat

blast off

Name: \_\_\_\_\_ Date: \_\_\_\_\_

a Z B y C X D

W E A V e F U

f t G S H R i

r L Q M P N O

4 6 3 1 2 5 8 7 10

Fat Cat

|           |           |           |
|-----------|-----------|-----------|
| 3         | 2         | 4         |
| <u>+4</u> | <u>+2</u> | <u>-1</u> |

Vowels: \_\_\_\_\_

blast off

Name: \_\_\_\_\_ Date: \_\_\_\_\_

f F v u p L r

f e a i s g G

H N A X Z

5 3 6 7 2 1 4 8

|           |           |           |           |           |
|-----------|-----------|-----------|-----------|-----------|
| 2         | 3         | 3         | 5         | 5         |
| <u>+4</u> | <u>+1</u> | <u>+4</u> | <u>+5</u> | <u>-2</u> |

Fat Cat Hat

Vowels: \_\_\_\_\_

blast off

Name: \_\_\_\_\_ Date: \_\_\_\_\_

V L P e a

I r F H

4 3 3  
+4 +1 -1

Name: \_\_\_\_\_ Date: \_\_\_\_\_

a z B w c x D

y e u E v F t

f s G r g R H

Q i p L N m o

3 6 4 2 5 8 1 7

Fat Cat Sat

3 5 4 3  
+2 +1 -2 -3

Vowels: \_\_\_\_\_

blast off

Name: \_\_\_\_\_ Date: \_\_\_\_\_

a e i o u y D z B

r v L H G f b p t

4 6 3 1 2 7 5 0 8 9 10

Fat Cat Sat Sam

|           |           |           |           |
|-----------|-----------|-----------|-----------|
| 1         | 3         | 5         | 4         |
| <u>+4</u> | <u>+5</u> | <u>-2</u> | <u>-0</u> |

Vowels: \_\_\_\_\_

blast off

Name: \_\_\_\_\_ Date: \_\_\_\_\_

b c a a e i D E Z

f G W F H x y L

N p R t s r b b B

3 6 7 2 8 4 10 5 9 1

|           |           |           |     |
|-----------|-----------|-----------|-----|
| 3         | 5         | 4         | fat |
| <u>+1</u> | <u>+5</u> | <u>-3</u> | cat |
|           |           |           | hat |
|           |           |           | sat |

Vowels: \_\_\_\_\_

blast off



Name: \_\_\_\_\_ Date: \_\_\_\_\_

Y M M A S y m m a s

K X I J T f m t

O u w R fat mat cat

Fat cat sat on the mat.

3      6      2      10      1  
                  +1                    +1

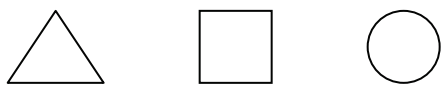

Vowels: \_\_\_\_\_

blast off

Name: \_\_\_\_\_ Date: \_\_\_\_\_

b D g j l n p u v 1 2

hop top mop pop

fat pat sat cat 10 8 5

3 0 6 5  
+4 +4 -2 -1

Vowels: \_\_\_\_\_

blast off

Name: \_\_\_\_\_ Date: \_\_\_\_\_

S a m y b w c A x

Z B r c t D p e Q

E R f o F n g N G

L h l H j i

4 6 3 2 7 8 2 9 10

2 5 8 9 4 3  
+4 +5 +3 +2 -1 -3

Vowels: \_\_\_\_\_

blast off

Name: \_\_\_\_\_ Date: \_\_\_\_\_

b L k x t h f g w k

r n u V D i k j l Q

3 8 10 2 9 6 4 11 7 5

hat sat rat fat mat tat

ham sam ran fan map tap

8 8 3 4 10  
+2 +4 +3 -2 -2

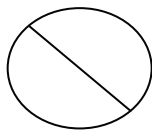
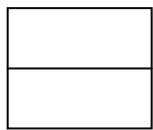
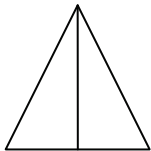

Vowels: \_\_\_\_\_

blast off

Name: \_\_\_\_\_ Date: \_\_\_\_\_

K k l f h x k Q b

hat hot hit

pat pot pit

cat cot

bat bit

2 13 5 10  
+9 +5 -3 -4

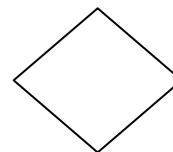
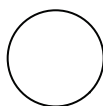
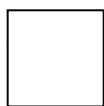

Vowels: \_\_\_\_\_

blast off

Name: \_\_\_\_\_ Date: \_\_\_\_\_

Q x k T V u M L P Q

3          6          4          5  
-3      +2      -2      -1

PAT THE CAT.

I CAN HOP.

I AM SAMMY.

Vowels: \_\_\_\_\_

blast off

Name: \_\_\_\_\_ Date: \_\_\_\_\_

K j l u v p k b x r

hat hot hit

top tap tip

the

$\begin{array}{r} 6 \\ +7 \\ \hline \end{array}$       $\begin{array}{r} 2 \\ +5 \\ \hline \end{array}$       $\begin{array}{r} 9 \\ -2 \\ \hline \end{array}$       $\begin{array}{r} 4 \\ -3 \\ \hline \end{array}$

Name shape and divide in half:

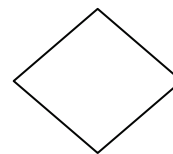
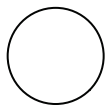
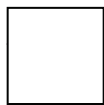

Vowels: \_\_\_\_\_

blast off

Name: \_\_\_\_\_ Date: \_\_\_\_\_

x b l m k Q g r i p

I am Sam. I can hop.

the no fat sit

|           |           |           |           |           |           |
|-----------|-----------|-----------|-----------|-----------|-----------|
| 2         | 2         | 6         | 9         | 3         | 10        |
| <u>+3</u> | <u>-2</u> | <u>+3</u> | <u>+4</u> | <u>-1</u> | <u>-3</u> |

$\frac{1}{2}$

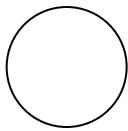

$\frac{1}{4}$

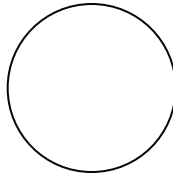

Vowels: \_\_\_\_\_

blast off



Name: \_\_\_\_\_ Date: \_\_\_\_\_

a B w c e D

O A R m L H

i N P S U T V

5 2 1 3 4 8

1 2  
+2 +3

Vowels: \_\_\_\_\_

blast off

Name: \_\_\_\_\_ Date: \_\_\_\_\_

b g j k l n u v x

5 8 10 2 4 6 3 1 7 9 11

I am Sam. I can run.

I can hit the ball. I am hot.

I see the cat.

$\frac{2}{+3}$      $\frac{4}{+3}$      $\frac{9}{+3}$      $\frac{2}{+0}$      $\frac{1}{-1}$      $\frac{3}{-1}$

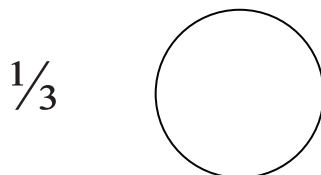
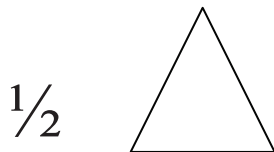

Vowels: \_\_\_\_\_

blast off

Name: \_\_\_\_\_ Date: \_\_\_\_\_

B r k l t x u g v h

6 2 1 3 7 9 4 5 8 10 11

100       $\frac{1}{2}$       12

I am a girl. I can see the cat.

I like cats.

$\begin{array}{r} 2 \\ +3 \\ \hline \end{array}$        $\begin{array}{r} 4 \\ +7 \\ \hline \end{array}$        $\begin{array}{r} 5 \\ -5 \\ \hline \end{array}$        $\begin{array}{r} 4 \\ -2 \\ \hline \end{array}$

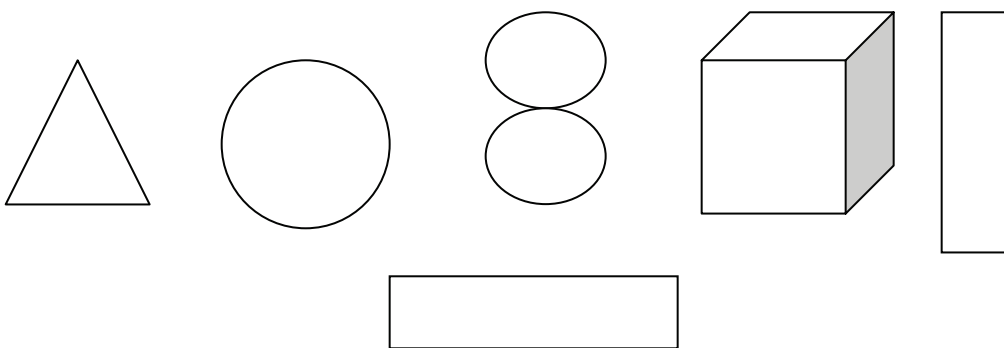

Vowels: \_\_\_\_\_

blast off

Name: \_\_\_\_\_ Age: \_\_\_\_\_

Write your brother's name: \_\_\_\_\_

Write the name of an animal: \_\_\_\_\_

5 8 10 2 4 6 3 1 7 9 11

I am Sam. I am not a cat.

the 3 7 11 10 5 4

$\begin{array}{r} 2 \\ +4 \\ \hline \end{array}$       $\begin{array}{r} 3 \\ +6 \\ \hline \end{array}$       $\begin{array}{r} 1 \\ +0 \\ \hline \end{array}$       $\begin{array}{r} 2 \\ -1 \\ \hline \end{array}$       $\begin{array}{r} 2 \\ -2 \\ \hline \end{array}$

Name each shape then divide in  $\frac{1}{2}$ :

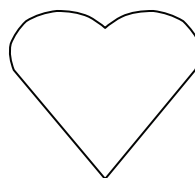
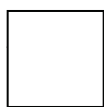
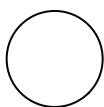

Vowels: \_\_\_\_\_

blast off

Name: \_\_\_\_\_ Age: \_\_\_\_\_

Q K X y T P B u r t

Sam cat sat hat

$\begin{array}{r} 2 \\ +3 \\ \hline \end{array}$        $\begin{array}{r} 5 \\ +1 \\ \hline \end{array}$        $\begin{array}{r} 2 \\ +2 \\ \hline \end{array}$       6      2      6

Name each shape then divide in  $\frac{1}{2}$ :

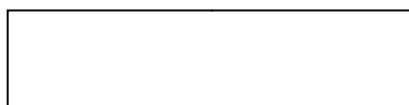
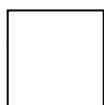
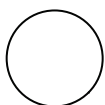

The “intersection is the area inside both shapes. Color the intersections red. Color the areas inside only one shape blue:

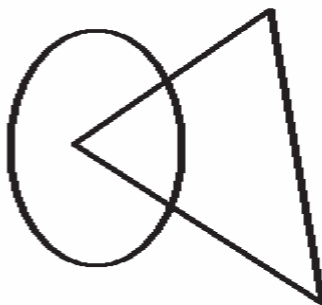
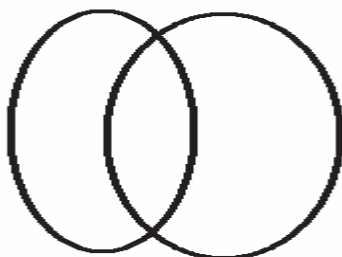

Vowels: \_\_\_\_\_

blast off

Name: \_\_\_\_\_ Date: \_\_\_\_\_

a c E f z w y x

D A e u p v b F

Q g r G R s h t H T

i m j N o k L n l

I

3 5 6 8 10 2 1 4 9 11

7 0

I am Sam. I can see the cat.

3 2 3 4 3 2  
+2 +4 +3 -1 -2 -2

Vowels: \_\_\_\_\_

blast off

Name: \_\_\_\_\_ Date: \_\_\_\_\_

r n b l p d g h q d p b f v d

6 4 10 7 11 8 12 14 16 18

soap hear coat feet seed

make rope fire coke

|           |           |           |           |           |           |
|-----------|-----------|-----------|-----------|-----------|-----------|
| 5         | 4         | 7         | 8         | 10        | 7         |
| <u>+6</u> | <u>-2</u> | <u>+5</u> | <u>+6</u> | <u>-3</u> | <u>-4</u> |

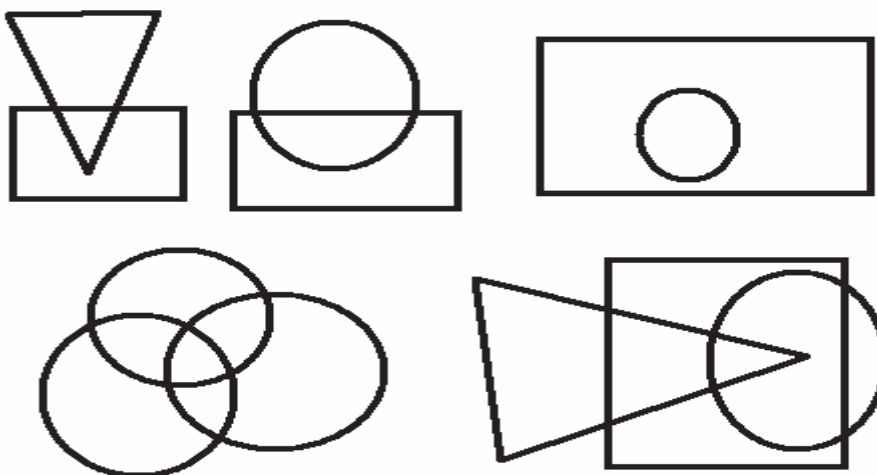

Vowels: \_\_\_\_\_

blast off

Name: \_\_\_\_\_ Date: \_\_\_\_\_

see      the      tea      boat

keep      heat      goat      hear

cake      coke      like

|           |           |           |           |           |
|-----------|-----------|-----------|-----------|-----------|
| 2         | 10        | 2         | 3         | 10        |
| <u>+7</u> | <u>+4</u> | <u>+0</u> | <u>-1</u> | <u>-3</u> |

Vowels: \_\_\_\_\_

blast off



Name: \_\_\_\_\_ Date: \_\_\_\_\_

hat fat hot rat

can ham tap top

The cat did not see the dog. The dog said,  
“Bark!!” The cat ran. Bye-Bye cat.

|           |           |           |           |           |           |
|-----------|-----------|-----------|-----------|-----------|-----------|
| 2         | 6         | 3         | 4         | 10        | 8         |
| <u>+4</u> | <u>+3</u> | <u>+0</u> | <u>-0</u> | <u>-1</u> | <u>-8</u> |

Vowels: \_\_\_\_\_

blast off

Name: \_\_\_\_\_ Date: \_\_\_\_\_

I like to eat meat.

I can eat an apple.

3 6 10 12 11 9 14

|           |           |           |           |           |           |
|-----------|-----------|-----------|-----------|-----------|-----------|
| 2         | 9         | 10        | 2         | 5         | 8         |
| <u>+4</u> | <u>+3</u> | <u>+5</u> | <u>-1</u> | <u>-2</u> | <u>-8</u> |

Name and divide in half.

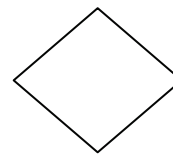
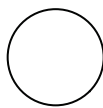
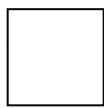

Vowels: \_\_\_\_\_

blast off

Name: \_\_\_\_\_ Date: \_\_\_\_\_

i r n u f v g h B p

hat hate 6 10 5 11

hop hope 4 9 12 3

car care 16 18 19 20

tap tape 17 14 13 12

I hope the cake is good.

I am hungry.

2 7 0 10 5 6  
+5 +6 +3 -4 -1 -2

Vowels: \_\_\_\_\_

blast off

Name: \_\_\_\_\_ Date: \_\_\_\_\_

b q h d b p g l j k b d

12 10 13 14 16 18 19

hear hair rain soak

tape fire lake bite

I can see the big fire.

8      13      9      10  
+3      +4      -3      -4

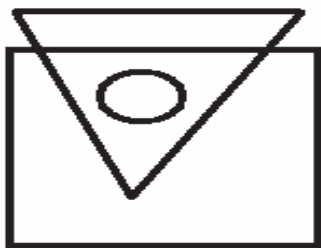

$\frac{1}{2}$      $\frac{1}{3}$

Vowels: \_\_\_\_\_

blast off

Name: \_\_\_\_\_ Date: \_\_\_\_\_

b g h q l r d p h b

12 10 13 14 16 18 19

hop ropes cat cakes do

see seed feed need to

I ate the big banana.

|           |           |           |           |           |
|-----------|-----------|-----------|-----------|-----------|
| 4         | 9         | 6         | 5         | 3         |
| <u>+8</u> | <u>+3</u> | <u>+6</u> | <u>-2</u> | <u>-3</u> |

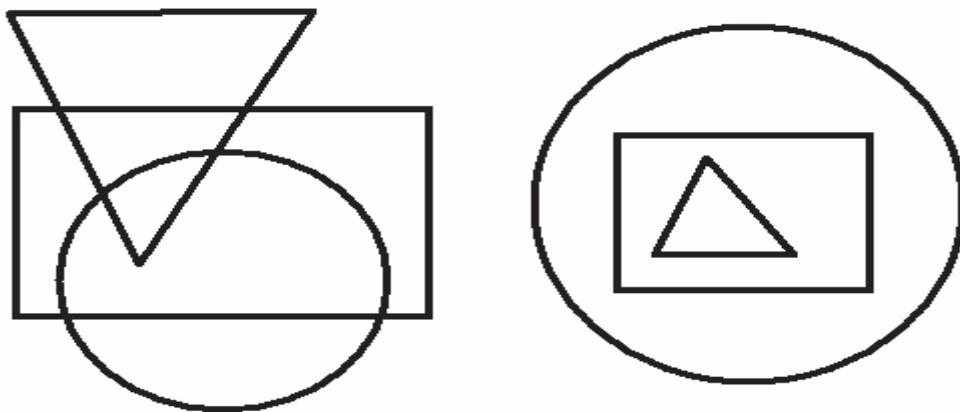

Vowels: \_\_\_\_\_

blast off

Name: \_\_\_\_\_ Date: \_\_\_\_\_

b l g r n q d h D B f p

keep peep steep me he

to do home kite bone

fat cat

I can eat the cake and the apple.

6      7      5      4      9  
+4    +3    +5    -1    -3

12 14 17 8 18 10 13 11

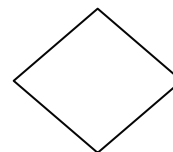
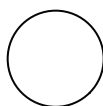
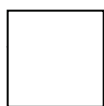

Vowels: \_\_\_\_\_

blast off

Name: \_\_\_\_\_ Date: \_\_\_\_\_

p d b q g l f h r n u v

hop pop hope

safe cake eat

I want to pet the fat cat

6 8 12 9 11 15 17 18

|           |           |           |           |           |
|-----------|-----------|-----------|-----------|-----------|
| 6         | 7         | 5         | 4         | 9         |
| <u>+4</u> | <u>+3</u> | <u>+5</u> | <u>-1</u> | <u>-3</u> |

Vowels: \_\_\_\_\_

blast off

Name: \_\_\_\_\_ Date: \_\_\_\_\_

p d b q g h l f r n u

I want to go to the toy store to get lots of toys.

4      12      6      10  
+5    +3    -2    -3

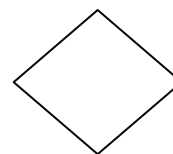
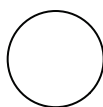
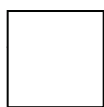

$\frac{1}{2}$        $\frac{1}{3}$        $\frac{1}{4}$        $\frac{1}{5}$       14

Vowels: \_\_\_\_\_

blast off



Name: \_\_\_\_\_ Date: \_\_\_\_\_

a e i o u h j w x p b

like hike bike rope

The cat sat on a hill and said, "Meow." The cat ate a big rat. Yum!

2      9      5      4      10  
+4    +2    +7    -1    -3

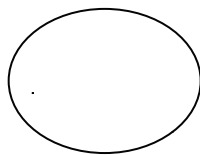
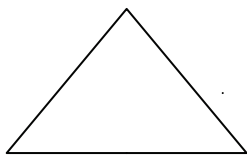

Vowels: \_\_\_\_\_

blast off

Name: \_\_\_\_\_ Date: \_\_\_\_\_

b x p g l h q r o i

cake hope hat toy

I am a big cat and I want to eat the dog.

|           |           |           |           |
|-----------|-----------|-----------|-----------|
| 2         | 6         | 8         | 6         |
| <u>+5</u> | <u>+3</u> | <u>-4</u> | <u>-1</u> |

Vowels: \_\_\_\_\_

blast off

Name: \_\_\_\_\_ Date: \_\_\_\_\_

6 11 18 13 12 19 17

15 16 14 1 10 23 25

sink part hill bug

The big girl can ride her bike very well!

|           |           |           |           |
|-----------|-----------|-----------|-----------|
| 2         | 9         | 6         | 8         |
| <u>+7</u> | <u>+5</u> | <u>-3</u> | <u>-8</u> |

Vowels: \_\_\_\_\_

blast off

Name: \_\_\_\_\_ Date: \_\_\_\_\_

c d f B F g j H x

k l p q b s v r w

say play stay day

toy boy tape want

I want to see the dog bite the rat on his tail.

|           |           |           |           |
|-----------|-----------|-----------|-----------|
| 2         | 4         | 3         | 5         |
| <u>+6</u> | <u>+8</u> | <u>-3</u> | <u>-3</u> |

Vowels: \_\_\_\_\_

blast off

Name: \_\_\_\_\_ Date: \_\_\_\_\_

24 26 29 14 18 17

11 12 10 22 20 21

sink pink stop last

make coke like tame

Sam is a big girl.

|           |           |           |           |
|-----------|-----------|-----------|-----------|
| 6         | 4         | 5         | 5         |
| <u>+6</u> | <u>+4</u> | <u>+5</u> | <u>-5</u> |

Vowels: \_\_\_\_\_

blast off

Name: \_\_\_\_\_ Date: \_\_\_\_\_

18 26 23 14 27 19 10 12 11 22 21 20

pot spot top stop

tap tape hop hope

I can see the big cat.

|           |           |           |           |
|-----------|-----------|-----------|-----------|
| 3         | 6         | 5         | 8         |
| <u>+4</u> | <u>+5</u> | <u>-1</u> | <u>-8</u> |

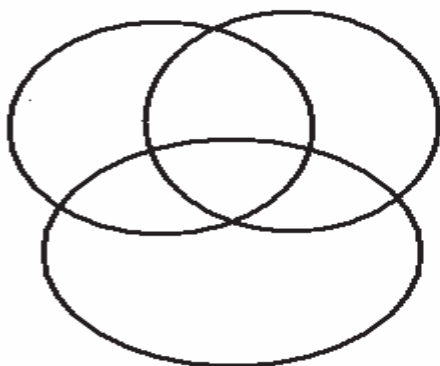

Vowels: \_\_\_\_\_

blast off

Name: \_\_\_\_\_ Date: \_\_\_\_\_

12 8 14 18 23 25 20 15

17 21 10 24 11

seed feed tree sky

I am the best girl on the cul-de-sac.

$\begin{array}{r} 6 \\ +7 \\ \hline \end{array}$        $\begin{array}{r} 3 \\ +8 \\ \hline \end{array}$        $\begin{array}{r} 5 \\ -2 \\ \hline \end{array}$        $\begin{array}{r} 23 \\ -23 \\ \hline \end{array}$

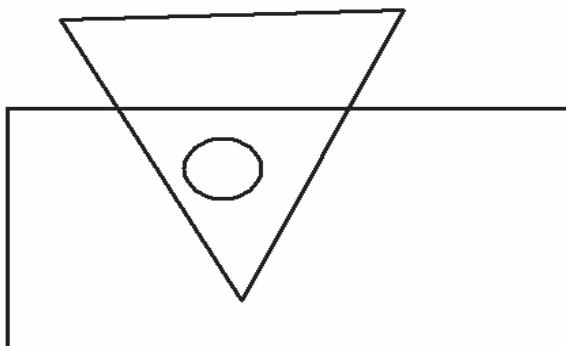

Vowels: \_\_\_\_\_

blast off

Name: \_\_\_\_\_ Date: \_\_\_\_\_

18 14 23 12 27 10 22

20 11 19 13 15 28 1

fast last list stop

The cat was mad. He ate the dog.

|           |           |           |           |
|-----------|-----------|-----------|-----------|
| 6         | 2         | 4         | 8         |
| <u>+8</u> | <u>+1</u> | <u>-3</u> | <u>-2</u> |

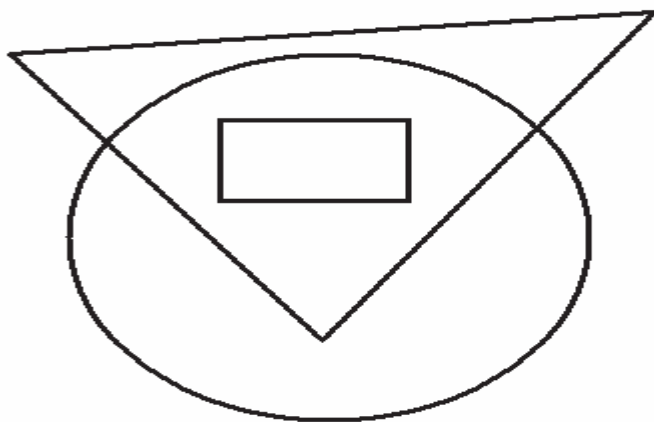

Vowels: \_\_\_\_\_

blast off



Name: \_\_\_\_\_ Date: \_\_\_\_\_

27 19 20 12 11 15 18

24 13 26 16 10 23 21

sink pink wink bat

sing ring king wing

The girl hit the ball with the bat.

$\begin{array}{r} 6 \\ +7 \\ \hline \end{array}$        $\begin{array}{r} 9 \\ +3 \\ \hline \end{array}$        $\begin{array}{r} 5 \\ -1 \\ \hline \end{array}$        $\begin{array}{r} 6 \\ -3 \\ \hline \end{array}$

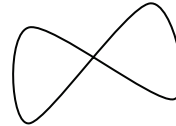
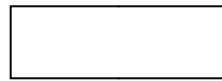
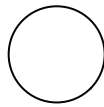
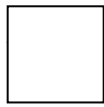

Vowels: \_\_\_\_\_

blast off

Name: \_\_\_\_\_ Date: \_\_\_\_\_

16 21 20 19 23 4 10 18

12 13 22 15 10 25 27

keep seed feed need

sent bent went tent

I like to go to the place where the swings are.

|           |           |           |           |
|-----------|-----------|-----------|-----------|
| 6         | 7         | 10        | 5         |
| <u>+6</u> | <u>+7</u> | <u>-2</u> | <u>-3</u> |

Vowels: \_\_\_\_\_

blast off

Name: \_\_\_\_\_ Date: \_\_\_\_\_

26 13 10 12 21 14 11 19 15 100 25

31 34 36 27 lip slip flip lips

talk walk sulk milk

The little girl did not drink her milk.

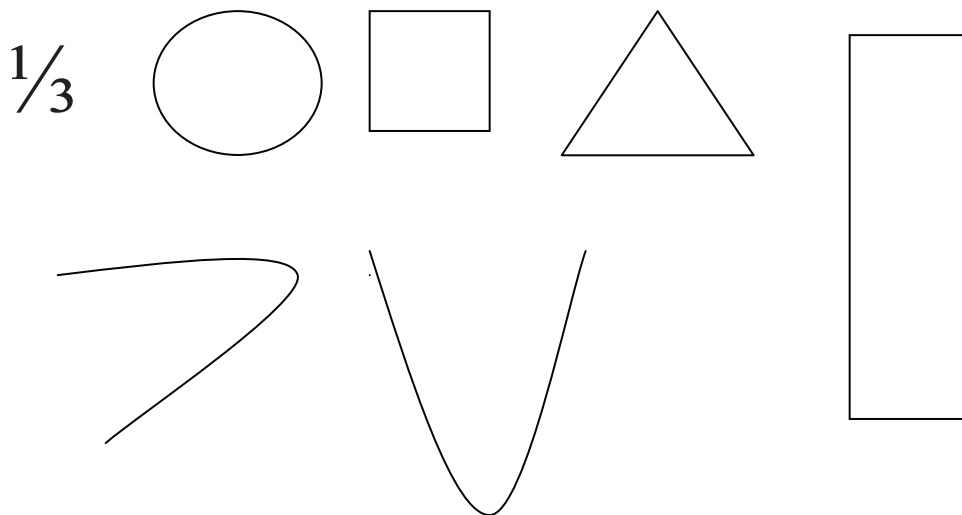

12      16      13      5  
+4      +3      -4      -1

Vowels: \_\_\_\_\_

blast off

Name: \_\_\_\_\_ Date: \_\_\_\_\_

29 16 29 12 22 10 31 18 24 11 20

35 32 30 4 nose hose rose cake

milk tank sink pink

I want to see the dog that ate the bug.

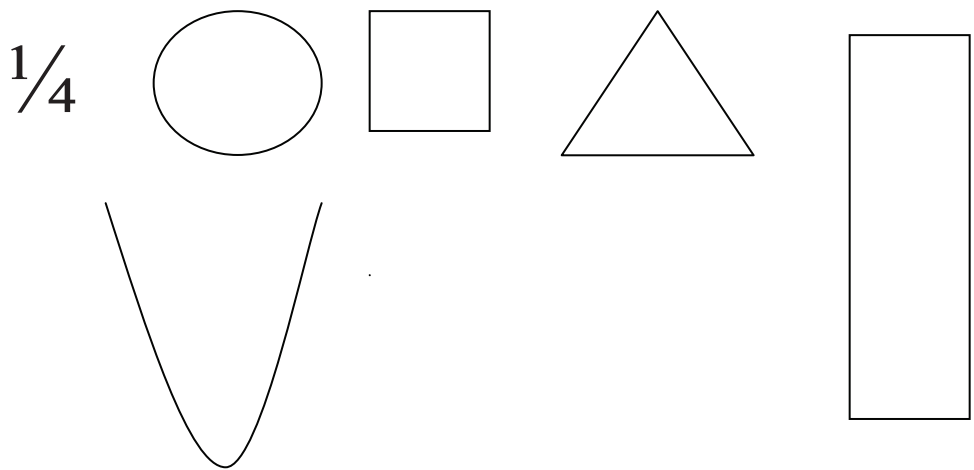

15      6      4      10      12  
+3    +7    -2    -10    -4

Vowels: \_\_\_\_\_

blast off

Name: \_\_\_\_\_ Date: \_\_\_\_\_

4 12 26 17 19 30 11 10 20 r e b

g l h i q j x k n u d

hair rain pair tail

Can you please get me a cup of milk? I am thirsty.

$\frac{1}{2}$

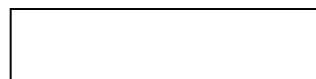
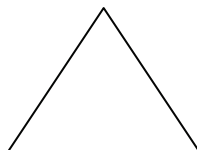
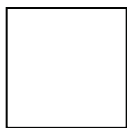
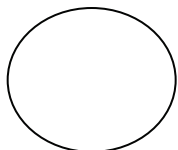

|           |           |           |           |           |           |
|-----------|-----------|-----------|-----------|-----------|-----------|
| 2         | 9         | 6         | 4         | 12        | 3         |
| <u>+3</u> | <u>+4</u> | <u>+6</u> | <u>-1</u> | <u>-3</u> | <u>-3</u> |

Vowels: \_\_\_\_\_

blast off

Name: \_\_\_\_\_ Date: \_\_\_\_\_

b          p          q          r          a

11          24          36          14

cat          hope          eat

I am Sam.

    2          3  
+4          -1

Vowels: \_\_\_\_\_

blast off

Name: \_\_\_\_\_ Date: \_\_\_\_\_

14 36 27 18 23 11 10 20 31 r g l

i q v p r n b d p h

run fun sun bun hate

I like to play with Kevin and Kara.

$\frac{1}{3}$

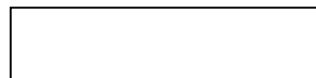
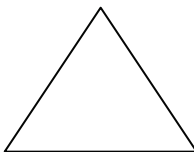
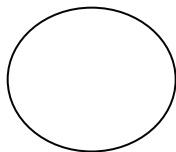

$\begin{array}{r} 7 \\ +3 \\ \hline \end{array}$      $\begin{array}{r} 8 \\ +0 \\ \hline \end{array}$      $\begin{array}{r} 6 \\ +5 \\ \hline \end{array}$      $\begin{array}{r} 9 \\ -2 \\ \hline \end{array}$      $\begin{array}{r} 1 \\ -0 \\ \hline \end{array}$      $\begin{array}{r} 8 \\ -8 \\ \hline \end{array}$

Vowels: \_\_\_\_\_

blast off

Name: \_\_\_\_\_ Date: \_\_\_\_\_

P l g r s p d h p b

28 13 10 20 35 15 34 clam close

click talk walk sulk milk

The boy said, "Stop! Do not hit the cat!"

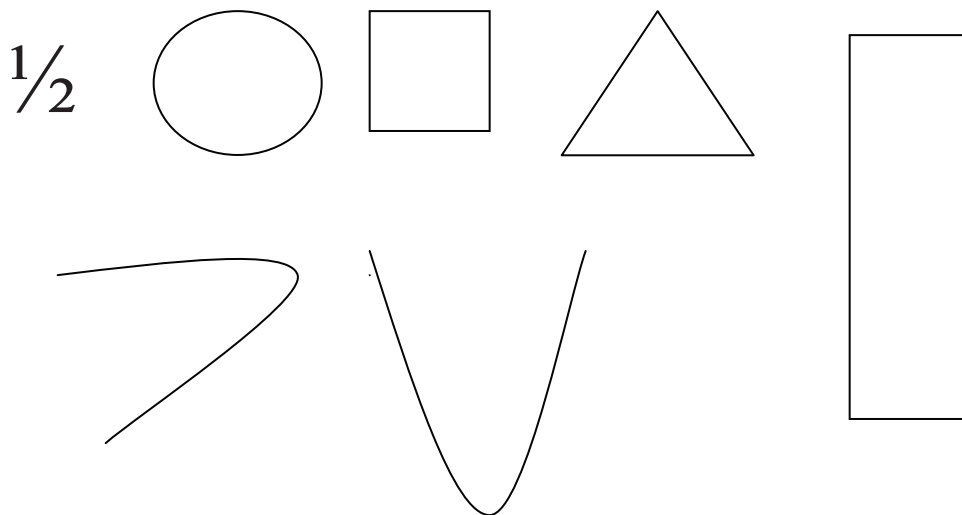

4      12      8      4  
+7      +6      -3      -1

Vowels: \_\_\_\_\_

blast off



Name: \_\_\_\_\_ Date: \_\_\_\_\_

x p l g r t p v d n u b

p slip slap slow sloppy

34 19 25 13 20 15 41 43

The little girl said, “Mom, can I go to Kara’s to play?”

|           |           |           |           |
|-----------|-----------|-----------|-----------|
| 8         | 9         | 3         | 12        |
| <u>+7</u> | <u>+3</u> | <u>-2</u> | <u>-3</u> |

Vowels: \_\_\_\_\_

blast off

Name: \_\_\_\_\_ Date: \_\_\_\_\_

p b d h f l g q p j

42 44 33 20 13 16 40

pay play say stay day

I want to play with Kara.

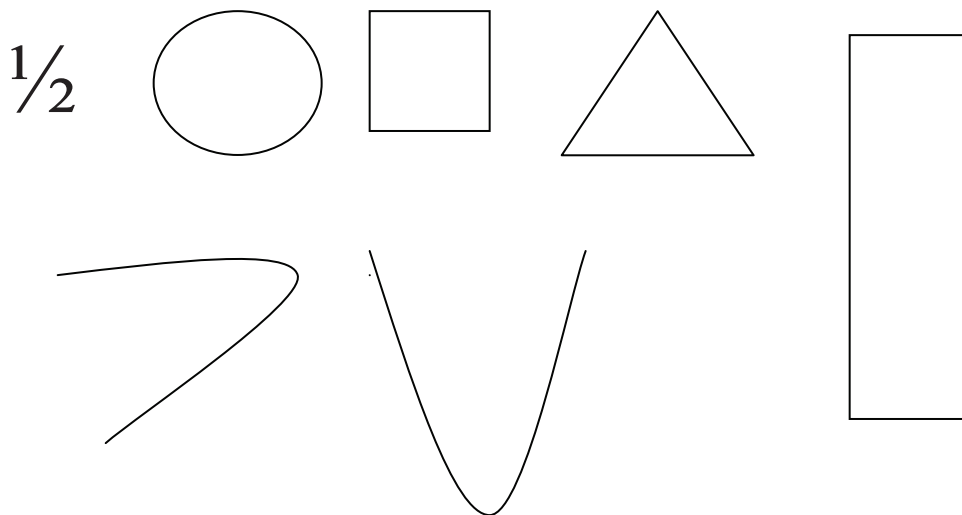

4      9      3      19  
+8    +6    -2    -3

Vowels: \_\_\_\_\_

blast off

Name: \_\_\_\_\_ Date: \_\_\_\_\_

p r g q p d b 6

23 46 37 18 3 10 50 40 30

running hitting sitting kicking

The small girl was very nice.

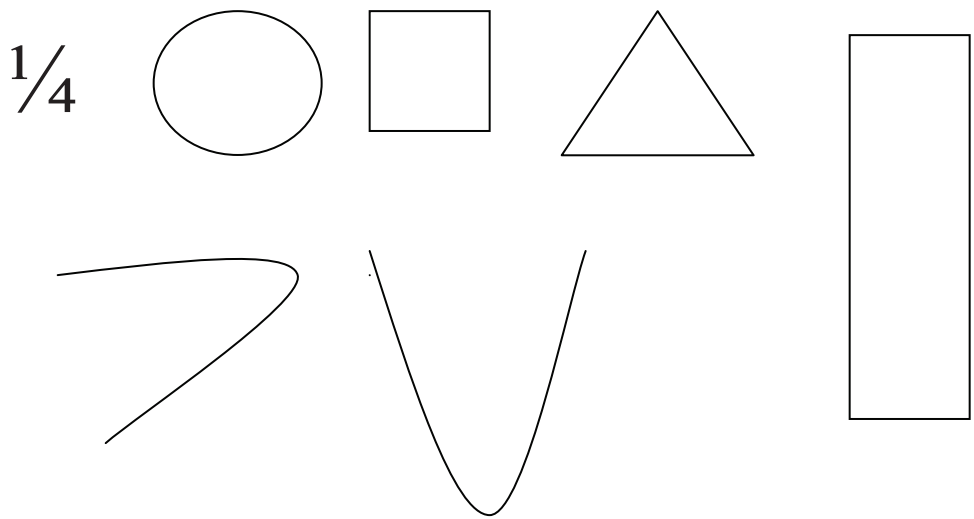

10      12      18      4  
+11    +14    -2      -2

Vowels: \_\_\_\_\_

blast off

Name: \_\_\_\_\_ Date: \_\_\_\_\_

g p h d b p q

47 49 52 10 54 38 24 12 66

cook book hook look

Roses are red,  
Violets are blue,  
Butterflies are pretty,  
And so are you.

|            |            |           |           |
|------------|------------|-----------|-----------|
| 16         | 16         | 2         | 5         |
| <u>+ 4</u> | <u>+13</u> | <u>-1</u> | <u>-3</u> |

Vowels: \_\_\_\_\_

blast off

Name: \_\_\_\_\_ Date: \_\_\_\_\_

p b d q l r g

47 92 83 14 21 35 75

slip stop smoke stay

I want to be a duck when I grow up.

|            |            |           |            |
|------------|------------|-----------|------------|
| 2          | 16         | 4         | 8          |
| <u>+ 7</u> | <u>+13</u> | <u>-3</u> | <u>- 8</u> |

Vowels: \_\_\_\_\_

blast off

Name: \_\_\_\_\_ Date: \_\_\_\_\_

p l d g r p b q

16 28 49 36 51 13 11 62

pair hair stairs chair

I dare you to cut your hair.

14      14      11      2  
+3      +13      -4      -2

red blue green yellow

$\frac{1}{2}$   $\frac{1}{3}$   $\frac{1}{4}$

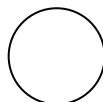

Vowels: \_\_\_\_\_

blast off

Name: \_\_\_\_\_ Date: \_\_\_\_\_

p h l r g f b d

64 93 87 74 51 40 32 21

boat float coat goat

I hope I can see a goat.

|           |            |           |           |
|-----------|------------|-----------|-----------|
| 8         | 12         | 4         | 8         |
| <u>+9</u> | <u>+12</u> | <u>-2</u> | <u>-2</u> |

Vowels: \_\_\_\_\_

blast off

Name: \_\_\_\_\_ Date: \_\_\_\_\_

p d l h g f b

14 10 21 36 88 91 70 100

sink pink think

I will eat the hot dog.

|            |            |           |            |
|------------|------------|-----------|------------|
| 8          | 12         | 2         | 8          |
| <u>+ 5</u> | <u>+12</u> | <u>-0</u> | <u>- 8</u> |

Vowels: \_\_\_\_\_

blast off



Name: \_\_\_\_\_ Date: \_\_\_\_\_

p q l r g h b d

26 100 93 15 13 30 47

feet seeds heat keep

I have two feet.

|           |            |           |           |           |
|-----------|------------|-----------|-----------|-----------|
| 4         | 12         | 3         | 5         | 0         |
| <u>+9</u> | <u>+13</u> | <u>-1</u> | <u>-2</u> | <u>-0</u> |

Vowels: \_\_\_\_\_

blast off

Name: \_\_\_\_\_ Date: \_\_\_\_\_

p t l r g m v j

sand hand land

How now brown cow?

|            |            |           |           |
|------------|------------|-----------|-----------|
| 6          | 12         | 4         | 3         |
| <u>+ 8</u> | <u>+15</u> | <u>-1</u> | <u>-3</u> |

Vowels: \_\_\_\_\_

blast off

Name: \_\_\_\_\_ Date: \_\_\_\_\_

p h l r g q b d j

16 93 40 57 21 32 12

sing king ring thing

I hope I can see a goat.

|            |            |            |            |
|------------|------------|------------|------------|
| 4          | 9          | 2          | 8          |
| <u>+ 3</u> | <u>+ 2</u> | <u>- 2</u> | <u>- 3</u> |

Vowels: \_\_\_\_\_

blast off

Name: \_\_\_\_\_ Date: \_\_\_\_\_

stop stamp stick pink

28 30 84 73 13 46 67

rabbit little giggle wiggle

The little girl said to her mother, “Mom, will I be a duck when I get big?” The Mom said, “Quack, quack.”

|           |           |           |           |
|-----------|-----------|-----------|-----------|
| 6         | 9         | 3         | 7         |
| <u>+1</u> | <u>+4</u> | <u>-1</u> | <u>-5</u> |

Vowels: \_\_\_\_\_

blast off

Name: \_\_\_\_\_ Date: \_\_\_\_\_

r k x u a a i p

10 23 12 87 100 21 93 101 15

snake slide sneak

I want to go to the playground. I will slide, and swing, and play in the sand.

|           |           |           |           |
|-----------|-----------|-----------|-----------|
| 8         | 2         | 10        | 4         |
| <u>+4</u> | <u>+3</u> | <u>-3</u> | <u>-4</u> |

Vowels: \_\_\_\_\_

blast off

Name: \_\_\_\_\_ Date: \_\_\_\_\_

d q j x n k b a p

21 12

100 23 51 104 39 110

plate clap sent broke

8 13 9 16  
+4 +24 -3 -2

The long car drove by while I was going to the toy store.

$\frac{1}{2}$

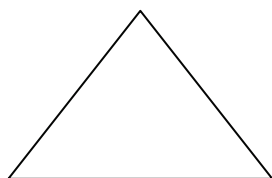

$\frac{1}{3}$

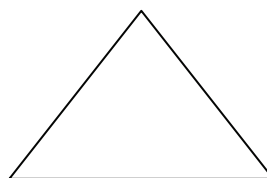

Vowels: \_\_\_\_\_

blast off

Name: \_\_\_\_\_ Date: \_\_\_\_\_

p d b l q h g k r w

16 91 101 110 100 25 12 110

sky try fly cry sun

|           |            |           |           |
|-----------|------------|-----------|-----------|
| 8         | 22         | 9         | 14        |
| <u>+3</u> | <u>+21</u> | <u>-1</u> | <u>-3</u> |

I like to read books about firemen.

Vowels: \_\_\_\_\_

blast off

Name: \_\_\_\_\_ Date: \_\_\_\_\_

p f l q D B k r

29 103 81 111 12 200

[Your child should read an easy book aloud]

I am a big girl.

|            |           |           |           |
|------------|-----------|-----------|-----------|
| 14         | 3         | 2         | 8         |
| <u>+13</u> | <u>+9</u> | <u>-2</u> | <u>-3</u> |

$\frac{1}{2}$

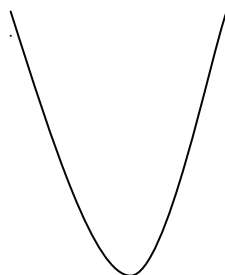
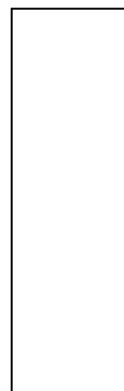
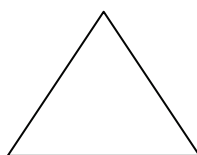
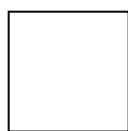
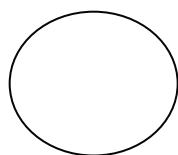

Vowels: \_\_\_\_\_

blast off



Name: \_\_\_\_\_ Date: \_\_\_\_\_

g r v x k Q d F b G p

16 11 31 12 21 13 115 121

At Halloween, the air is full of witches, and the pumpkins smile at you.

$\begin{array}{r} 16 \\ +12 \\ \hline \end{array}$      $\begin{array}{r} 7 \\ +7 \\ \hline \end{array}$      $\begin{array}{r} 9 \\ -1 \\ \hline \end{array}$      $\begin{array}{r} 14 \\ -3 \\ \hline \end{array}$      $\frac{1}{3}$      $\frac{1}{5}$

$\frac{1}{2}$

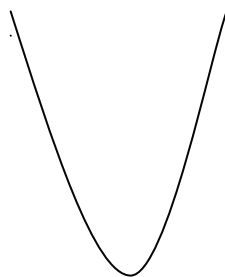
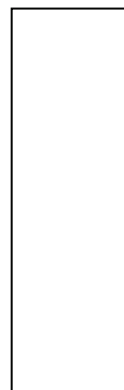
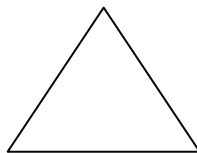
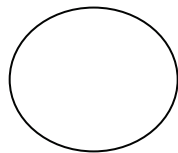

Vowels: \_\_\_\_\_

blast off

Name: \_\_\_\_\_ Date: \_\_\_\_\_

F Q P B S t u v m

My name is Sammy.

34 76 201 210 131 26 45

$\begin{array}{r} 5 \\ +4 \\ \hline \end{array}$     $\begin{array}{r} 6 \\ +4 \\ \hline \end{array}$     $\begin{array}{r} 4 \\ +4 \\ \hline \end{array}$     $\begin{array}{r} 6 \\ -4 \\ \hline \end{array}$     $\begin{array}{r} 4 \\ -4 \\ \hline \end{array}$

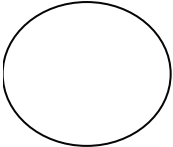
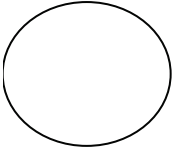
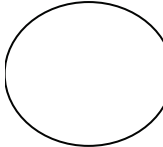
$\frac{1}{2}$      $\frac{1}{3}$      $\frac{1}{4}$  

Vowels: \_\_\_\_\_

blast off

Name: \_\_\_\_\_ Date: \_\_\_\_\_

r x u a p l t m d v b

14 27 61 21 11 104 123

sick stick pick kick

The little girl said, "Go home, you bad cat. Do not poop in my yard!".

|           |            |           |           |
|-----------|------------|-----------|-----------|
| 6         | 21         | 18        | 9         |
| <u>+9</u> | <u>+34</u> | <u>-2</u> | <u>-5</u> |

Vowels: \_\_\_\_\_

blast off

Name: \_\_\_\_\_ Date: \_\_\_\_\_

s k x t o a l d b p h r

v u w 19 21 12 13 111 104 122

146 191 200

might right sight fight tight

|            |           |           |            |           |
|------------|-----------|-----------|------------|-----------|
| 24         | 9         | 2         | 33         | 4         |
| <u>+34</u> | <u>+8</u> | <u>+1</u> | <u>-21</u> | <u>-4</u> |

I might go to the new school to see the ball game.

$\frac{1}{2}$   $\frac{1}{3}$   $\frac{1}{4}$   $\frac{1}{5}$   $\frac{2}{5}$

Vowels: \_\_\_\_\_

blast off

Name: \_\_\_\_\_ Date: \_\_\_\_\_

Word: \_\_\_\_\_

196    29    121    104    203

hop    hope    smoke    fire

The little girl said, "Fire!" when she saw the smoke.

|            |            |            |            |             |           |
|------------|------------|------------|------------|-------------|-----------|
| 6          | 23         | 38         | 55         | 26          | 9         |
| <u>+ 7</u> | <u>+34</u> | <u>-24</u> | <u>+23</u> | <u>- 16</u> | <u>+6</u> |

Vowels: \_\_\_\_\_

blast off

Name: \_\_\_\_\_ Date: \_\_\_\_\_

Word: \_\_\_\_\_

x l b d h n v u p

93 26 41 3 102 121 164

happen rotten butter

The nice little girl took the dog for a walk.

|           |            |           |           |           |
|-----------|------------|-----------|-----------|-----------|
| 1         | 23         | 0         | 4         | 9         |
| <u>+4</u> | <u>+31</u> | <u>-0</u> | <u>-2</u> | <u>+8</u> |

Vowels: \_\_\_\_\_

blast off

Name: \_\_\_\_\_ Date: \_\_\_\_\_

Favorite Food: \_\_\_\_\_

26      126      31      131      94      294

smoke      snake      spoon      shy

0   1   2   3   4   5   6   7   8   9    $\alpha$     $\beta$

|      |  |     |  |      |  |     |  |       |  |      |  |     |
|------|--|-----|--|------|--|-----|--|-------|--|------|--|-----|
| 10's |  | 1's |  | 10's |  | 1's |  | 100's |  | 10's |  | 1's |
|      |  |     |  |      |  |     |  |       |  |      |  |     |
|      |  |     |  |      |  |     |  |       |  |      |  |     |
|      |  |     |  |      |  |     |  |       |  |      |  |     |
|      |  |     |  |      |  |     |  |       |  |      |  |     |
|      |  |     |  |      |  |     |  |       |  |      |  |     |
|      |  |     |  |      |  |     |  |       |  |      |  |     |
|      |  |     |  |      |  |     |  |       |  |      |  |     |
|      |  |     |  |      |  |     |  |       |  |      |  |     |
|      |  |     |  |      |  |     |  |       |  |      |  |     |

Vowels: \_\_\_\_\_

blast off

Name: \_\_\_\_\_ Date: \_\_\_\_\_

Favorite Brother: \_\_\_\_\_

x l b d n v u p q l k f

91 23 143 6 103 21 112

happy silly goofy funny

I want to go to see a movie.

|           |            |           |           |           |
|-----------|------------|-----------|-----------|-----------|
| 3         | 18         | 10        | 4         | 9         |
| <u>+4</u> | <u>+11</u> | <u>-3</u> | <u>-2</u> | <u>+5</u> |

Hard word: \_\_\_\_\_

Vowels: \_\_\_\_\_

blast off



Name: \_\_\_\_\_ Date: \_\_\_\_\_

Mom's Name: \_\_\_\_\_

A B a b C D c d P Q p q

I am a big girl now.

|           |            |           |           |
|-----------|------------|-----------|-----------|
| 3         | 10         | 7         | 6         |
| <u>+4</u> | <u>+21</u> | <u>-3</u> | <u>-2</u> |

Vowels: \_\_\_\_\_

blast off

Name: \_\_\_\_\_ Date: \_\_\_\_\_

Favorite Word: \_\_\_\_\_

g l b d n v u p q l k f

r j 61 202 493 113 21 12

see to go me he be

The tall girl went to her school and played games.

|            |            |           |           |
|------------|------------|-----------|-----------|
| 9          | 16         | 13        | 4         |
| <u>+ 7</u> | <u>+13</u> | <u>-4</u> | <u>-2</u> |

Vowels: \_\_\_\_\_

blast off

Name: \_\_\_\_\_ Date: \_\_\_\_\_

Word: \_\_\_\_\_

p q l h d b r y j

19 84 73 102 232

hat take boat coat

I took the book to school.

|            |            |           |           |
|------------|------------|-----------|-----------|
| 14         | 16         | 8         | 9         |
| <u>+ 1</u> | <u>+23</u> | <u>-3</u> | <u>-9</u> |

Vowels: \_\_\_\_\_

blast off

Name: \_\_\_\_\_ Date: \_\_\_\_\_

Favorite Boy: \_\_\_\_\_

p l q j k x h d b

214 931 101 63 13 10

hoop poop cook book

The big dog said, "Roof!"

|            |            |           |            |            |
|------------|------------|-----------|------------|------------|
| 6          | 11         | 8         | 6          | 18         |
| <u>+ 3</u> | <u>+14</u> | <u>-8</u> | <u>- 2</u> | <u>+14</u> |

Vowels: \_\_\_\_\_

blast off

Name: \_\_\_\_\_ Date: \_\_\_\_\_

Favorite Animal: \_\_\_\_\_

p          d          b          j          q          g

266      923      86      101      47

carrot          apple          lemon          chicken

I ate a turkey sandwich for lunch.

|             |            |           |            |
|-------------|------------|-----------|------------|
| 16          | 18         | 3         | 8          |
| <u>+ 16</u> | <u>+12</u> | <u>-3</u> | <u>- 2</u> |

Vowels: \_\_\_\_\_

blast off

Name: \_\_\_\_\_ Date: \_\_\_\_\_

Favorite Animal: \_\_\_\_\_

j k q h g d p b

293 13 21 12 800 121

want talk shop sink

I want to eat hamburgers for dinner.

16 Place System: 123 920 816  
+24

Vowels: \_\_\_\_\_

blast off

Name: \_\_\_\_\_ Date: \_\_\_\_\_

Favorite Fruit: \_\_\_\_\_

p d l v x r z n u

K r o n s t a d t

112 26 19 13 301 47

hand want slot pants

I can draw a heart for my Valentine's Day card.

$$\begin{array}{r} 19 \\ + 12 \\ \hline \end{array}$$

$$\begin{array}{r} 14 \\ + 23 \\ \hline \end{array}$$

$$\begin{array}{r} 6 \\ - 4 \\ \hline \end{array}$$

$$\begin{array}{r} 8 \\ - 2 \\ \hline \end{array}$$

Vowels: \_\_\_\_\_

blast off

Name: \_\_\_\_\_ Date: \_\_\_\_\_

Age: \_\_\_\_\_

A a a B b C c D d P p

Q q G g

121 262 12 135 13

(Ask your child to write in the word “not” in the space provided if she wants)

I am Sammy.

|             |            |           |            |           |
|-------------|------------|-----------|------------|-----------|
| 8           | 18         | 5         | 3          | 1         |
| <u>+ 12</u> | <u>+23</u> | <u>-4</u> | <u>- 3</u> | <u>+1</u> |

path port part

Vowels: \_\_\_\_\_

blast off



Name: \_\_\_\_\_ Date: \_\_\_\_\_

Favorite Animal: \_\_\_\_\_

212      63      903      400      361

octopus      snake      lizard      alligator

The little girl was such a good reader, children came from all around to hear her read. After she finished reading a long story, they proclaimed her the “Queen of Light and Air.”

|             |           |           |            |
|-------------|-----------|-----------|------------|
| 19          | 6         | 6         | 8          |
| <u>+ 24</u> | <u>+8</u> | <u>-4</u> | <u>- 3</u> |

Vowels: \_\_\_\_\_

blast off

Name: \_\_\_\_\_ Date: \_\_\_\_\_

skate          break          talk

193    266          480    12    300

“When you are hot, you are hot!”

|            |            |            |           |
|------------|------------|------------|-----------|
| 26         | 3          | 26         | 11        |
| <u>+15</u> | <u>+19</u> | <u>-14</u> | <u>-3</u> |

$\frac{1}{2}$

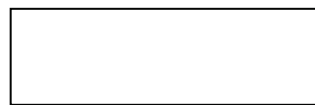
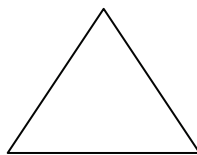
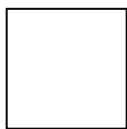
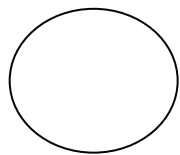

Vowels: \_\_\_\_\_

blast off

Name: \_\_\_\_\_ Date: \_\_\_\_\_

720    912    113    64    212

crawling    trying    seeing    driving

|             |           |            |           |            |
|-------------|-----------|------------|-----------|------------|
| 266         | 8         | 29         | 4         | 872        |
| <u>+345</u> | <u>+7</u> | <u>-12</u> | <u>-3</u> | <u>- 0</u> |

If I can, I want to be a singer when I grow up.

Fractions:  $\frac{1}{2}$      $\frac{1}{3}$      $\frac{1}{4}$      $\frac{2}{3}$

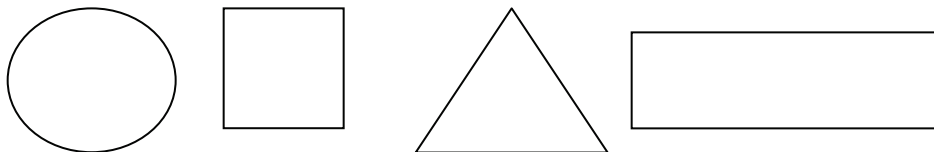

Vowels: \_\_\_\_\_

blast off

Name: \_\_\_\_\_ Date: \_\_\_\_\_

skunk          stamp          help

169      301      412

|             |           |            |             |
|-------------|-----------|------------|-------------|
| 569         | 8         | 10         | 49          |
| <u>+453</u> | <u>+7</u> | <u>- 2</u> | <u>- 21</u> |

I have three sisters and one brother. I also have two puppies.

Fractions:

|               |               |               |               |               |
|---------------|---------------|---------------|---------------|---------------|
| $\frac{1}{5}$ | $\frac{2}{3}$ | $\frac{3}{2}$ | $\frac{1}{4}$ | $\frac{1}{9}$ |
|---------------|---------------|---------------|---------------|---------------|

Vowels: \_\_\_\_\_

blast off

Name: \_\_\_\_\_ Date: \_\_\_\_\_

helping      kissing      seeing      being

801      916      330      47      111

The boy wanted to see a movie, but the girl wanted to eat out at Eat-n-Park. Guess who won?

$$\begin{array}{r} 69 \\ +24 \\ \hline \end{array}$$

$$\begin{array}{r} 69 \\ +31 \\ \hline \end{array}$$

$$\begin{array}{r} 19 \\ - 4 \\ \hline \end{array}$$

$$\begin{array}{r} 27 \\ - 0 \\ \hline \end{array}$$

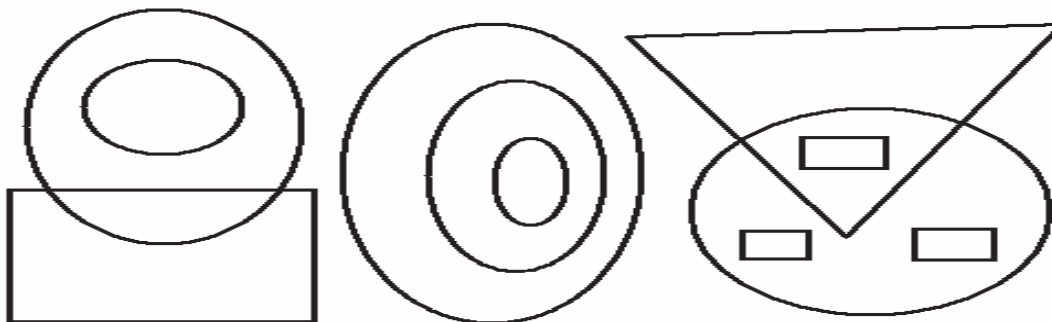

Vowels: \_\_\_\_\_

blast off

Name: \_\_\_\_\_ Date: \_\_\_\_\_

hard            complain            sting

191    363    1,001    400

Now that I am five, I can chew gum!

|            |           |            |             |
|------------|-----------|------------|-------------|
| 96         | 4         | 7          | 64          |
| <u>+25</u> | <u>+9</u> | <u>- 2</u> | <u>- 31</u> |

Fractions:

|               |               |               |                |               |
|---------------|---------------|---------------|----------------|---------------|
| $\frac{1}{5}$ | $\frac{2}{3}$ | $\frac{3}{2}$ | $\frac{9}{10}$ | $\frac{6}{7}$ |
|---------------|---------------|---------------|----------------|---------------|

Vowels: \_\_\_\_\_

blast off

Name: \_\_\_\_\_ Date: \_\_\_\_\_

soap    keep    taste    bringing

163    200    47    21    2,001

Once upon a time there was a beautiful princess who was in love with a frog. Fortunately, she married a prince instead.

|             |           |            |            |
|-------------|-----------|------------|------------|
| 39          | 6         | 86         | 5          |
| <u>+ 82</u> | <u>+5</u> | <u>-25</u> | <u>- 3</u> |

Vowels: \_\_\_\_\_

blast off

Name: \_\_\_\_\_ Date: \_\_\_\_\_

wash          bush          wish          fish

186      901      1,216      483

The little girl said, “When can I go play with my friend Kara?”

|             |            |           |             |
|-------------|------------|-----------|-------------|
| 18          | 96         | 6         | 26          |
| <u>+ 44</u> | <u>+25</u> | <u>-3</u> | <u>- 13</u> |

Multiplication:       $2 \cdot 3 =$  \_\_\_\_\_  
                                  $2 \times 3 =$  \_\_\_\_\_  
                                  $2 \times 4 =$  \_\_\_\_\_  
                                  $3 \times 2 =$  \_\_\_\_\_

Vowels: \_\_\_\_\_

blast off



Name: \_\_\_\_\_ Date: \_\_\_\_\_

chicken      cheese      cheap      chip

811      2,012      1,106      480

Today is a good day because Sammy and Kara both go to Friday Fun. Then, Sammy has a birthday party.

|             |             |           |              |
|-------------|-------------|-----------|--------------|
| 89          | 194         | 11        | 464          |
| <u>+ 34</u> | <u>+266</u> | <u>-3</u> | <u>- 223</u> |

$2 \cdot 4 =$  \_\_\_\_\_  $3 \cdot 4 =$  \_\_\_\_\_  $4 \cdot 2 =$  \_\_\_\_\_

|          |          |          |          |
|----------|----------|----------|----------|
| <u>1</u> | <u>2</u> | <u>3</u> | <u>1</u> |
| 2        | 3        | 4        | 10       |

Vowels: \_\_\_\_\_

blast off

Name: \_\_\_\_\_ Date: \_\_\_\_\_

house      peace      race      face

899      2,201      460

My favorite band is the Beatles.

|            |             |           |             |
|------------|-------------|-----------|-------------|
| 2          | 196         | 4         | 86          |
| <u>+ 1</u> | <u>+315</u> | <u>-0</u> | <u>- 23</u> |

$2 \cdot 1 = \underline{\quad}$

|            |            |
|------------|------------|
| 2          | 3          |
| <u>x 2</u> | <u>x 1</u> |

$3 \times 2 = \underline{\quad}$

Vowels: \_\_\_\_\_

blast off

Name: \_\_\_\_\_ Date: \_\_\_\_\_

tiger lion leopard jaguar

803 1,214 3,632 10,000

When I am thirty, I want to be a doctor and have two children (a boy and a girl).

**BORROWING!!! NEW!!**

|            |           |            |            |
|------------|-----------|------------|------------|
| 84         | 3         | 50         | 31         |
| <u>+37</u> | <u>+1</u> | <u>-12</u> | <u>-12</u> |

$2 \cdot 2 = \underline{\quad}$

|            |            |
|------------|------------|
| 3          | 3          |
| <u>x 2</u> | <u>x 1</u> |

Vowels: \_\_\_\_\_

blast off

Name: \_\_\_\_\_ Date: \_\_\_\_\_

160      2,381      1,009      48

castle      whistle      dragon      sword

|             |            |             |            |
|-------------|------------|-------------|------------|
| 18          | 1          | 81          | 20         |
| <u>+ 43</u> | <u>+ 1</u> | <u>- 13</u> | <u>- 3</u> |

The mighty dragon roared and breathed fire.

$2 \cdot 4 = \underline{\quad}$        $3 \cdot 1 = \underline{\quad}$        $\begin{array}{r} 2 \\ \times 2 \\ \hline \end{array}$

$\frac{1}{2}$        $\frac{1}{3}$        $\frac{1}{5}$        $\frac{1}{10}$

Vowels: \_\_\_\_\_

blast off

Name: \_\_\_\_\_ Date: \_\_\_\_\_

443      3,201      60      902

sinking    feeling    seeing    being    hitting

|             |            |            |             |           |
|-------------|------------|------------|-------------|-----------|
| 84          | 96         | 43         | 81          | 3         |
| <u>+ 21</u> | <u>+15</u> | <u>-11</u> | <u>- 14</u> | <u>-2</u> |

Bye, bye Miss American Pie. Drove the Chevy  
to the levee but the levee was dry.

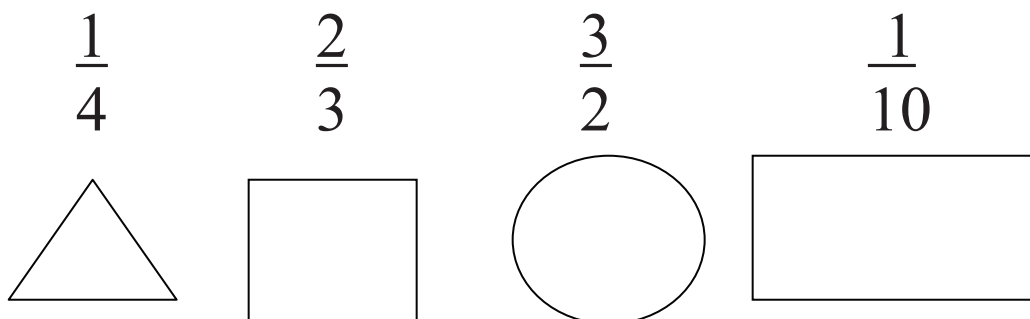

Vowels: \_\_\_\_\_

blast off

Name: \_\_\_\_\_ Date: \_\_\_\_\_

3,333      101      110

time      mime      lime      bye

Read Book!

$$\begin{array}{r} 5 \\ + 6 \\ \hline \end{array}$$

$$\begin{array}{r} 25 \\ + 6 \\ \hline \end{array}$$

$$\begin{array}{r} 120 \\ - 18 \\ \hline \end{array}$$

$$\begin{array}{r} 13 \\ + 12 \\ \hline \end{array}$$

$$\begin{array}{r} 6 \\ - 3 \\ \hline \end{array}$$

$\frac{1}{4}$



—

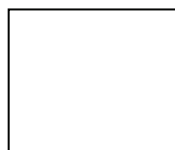

—

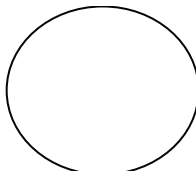

—

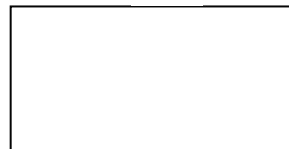

$2 \cdot 2 = \underline{\quad}$

$2 \cdot 3 = \underline{\quad}$

Vowels: \_\_\_\_\_

blast off

Name: \_\_\_\_\_ Date: \_\_\_\_\_

g q k x p l d b r v

tell bell heat heart cry

619 2,401 3,001 200

Math is very fun, but reading stories is even more fun!

|            |            |            |             |
|------------|------------|------------|-------------|
| 23         | 96         | 41         | 90          |
| <u>- 4</u> | <u>+15</u> | <u>-22</u> | <u>- 16</u> |

$1 \cdot 5 = \underline{\quad}$

|            |            |
|------------|------------|
| 4          | 2          |
| <u>x 2</u> | <u>x 4</u> |

$2 \times 3 = \underline{\quad}$

$3 \times 2 = \underline{\quad}$

Vowels: \_\_\_\_\_

blast off

Name: \_\_\_\_\_ Date: \_\_\_\_\_

649      2,318      1,001      204

[Pick a book and read from it.]

|            |            |            |             |           |
|------------|------------|------------|-------------|-----------|
| 4          | 27         | 41         | 83          | 6         |
| <u>- 0</u> | <u>+49</u> | <u>-22</u> | <u>- 61</u> | <u>+8</u> |

Last night I had the strangest dream I ever dreamed before. I dreamed the world had all agreed to put an end to war.

$3 \cdot 2 = \underline{\quad}$

$5 \times 2 =$

$2 \times 4 = \underline{\quad}$

$2 \times 5 =$

Vowels: \_\_\_\_\_

blast off



Name: \_\_\_\_\_ Date: \_\_\_\_\_

93      2,417      2,012

[Pick a book and read from it.]

car      far      party

|             |            |            |             |
|-------------|------------|------------|-------------|
| 81          | 93         | 42         | 63          |
| <u>- 14</u> | <u>+18</u> | <u>+21</u> | <u>- 12</u> |

$3 \cdot 3 = \underline{\quad}$

$5 \times 3 =$

$2 \times 4 = \underline{\quad}$

Vowels: \_\_\_\_\_

blast off

Name: \_\_\_\_\_ Date: \_\_\_\_\_

300      2,222      1,091      406

[Pick a book and read from it.]

runner      hitter      singer      eater

19      27      41      86  
- 7      +39      +41      - 23

Roses are red,  
Violets are blue,  
Tommy is nice,  
And so are you.

$3 \cdot 5 = \underline{\quad}$        $2 \times 6 =$

Vowels: \_\_\_\_\_

blast off

Name: \_\_\_\_\_ Date: \_\_\_\_\_

5,219      301      4,007

[Pick a book and read from it.]

high    sigh    tight    night    fight

|            |            |             |             |
|------------|------------|-------------|-------------|
| 14         | 13         | 695         | 81          |
| <u>- 6</u> | <u>+28</u> | <u>+436</u> | <u>- 15</u> |

|            |           |           |            |            |
|------------|-----------|-----------|------------|------------|
| 2          | 6         | 9         | 4          | 9          |
| <u>- 0</u> | <u>+4</u> | <u>+3</u> | <u>- 3</u> | <u>- 3</u> |

$3 \cdot 3 = \underline{\quad}$

$2 \times 5 =$

Vowels: \_\_\_\_\_

blast off

Name: \_\_\_\_\_ Date: \_\_\_\_\_

630      912      2,002      4,030

[Pick a book and read from it.]

bottle      piglet      high      sight

|            |           |            |
|------------|-----------|------------|
| 13         | 6         | 69         |
| <u>+ 4</u> | <u>+8</u> | <u>+21</u> |

The pretty girl said, “How high can you jump?”

“R” practice:      run      red      rag  
                         her      car      sore  
                         girl

Vowels: \_\_\_\_\_

blast off

Name: \_\_\_\_\_ Date: \_\_\_\_\_

6,496      283      10,306      201

blocks      talk      help      thin

28      6      28      41  
-12      -4      +24      -13

The puppies are very frisky in the morning!

More "R" practice:

car      curl      red      far

$2 \cdot 3 = \underline{\quad}$       3      4  
                                 x 1      x 2

Vowels: \_\_\_\_\_

blast off

Name: \_\_\_\_\_ Date: \_\_\_\_\_

621      1,390      11,401      701

car      her      singer      truck      girl

|            |           |            |            |           |
|------------|-----------|------------|------------|-----------|
| 97         | 4         | 28         | 41         | 3         |
| <u>+64</u> | <u>-1</u> | <u>+24</u> | <u>-13</u> | <u>+8</u> |

The little girl asked her father, “What will I be when I grow up?”

2 x 6 = \_\_\_\_\_

|            |            |
|------------|------------|
| 3          | 4          |
| <u>x 2</u> | <u>x 1</u> |

Vowels: \_\_\_\_\_

blast off

Name: \_\_\_\_\_ Date: \_\_\_\_\_

281      6,911      12,302      47

bump      crowd      clever      clown

Addition:

|            |           |            |           |           |
|------------|-----------|------------|-----------|-----------|
| 86         | 9         | 12         | 8         | 2         |
| <u>+45</u> | <u>+1</u> | <u>+13</u> | <u>+6</u> | <u>+1</u> |

I like school, but I miss the dogs while I am away.

Run      red      girl      her      car

Vowels: \_\_\_\_\_

blast off

Name: \_\_\_\_\_ Date: \_\_\_\_\_

849      2,319      12,222      1,001

far      her      run      tiger      girl      hurt

|           |            |            |            |           |           |
|-----------|------------|------------|------------|-----------|-----------|
| 4         | 21         | 63         | 63         | 12        | 1         |
| <u>-2</u> | <u>-10</u> | <u>+19</u> | <u>-19</u> | <u>+7</u> | <u>+2</u> |

What do you want? Who is she? Where are we going? Why? When will we get there?

$3 \cdot 3 = \underline{\quad}$        $5 \times 2 =$

$3 \times 5 = \underline{\quad}$

Vowels: \_\_\_\_\_

blast off



Name: \_\_\_\_\_ Date: \_\_\_\_\_

1,234      13,001      410      6,030

runner      trying      clap      stink

|           |            |            |            |
|-----------|------------|------------|------------|
| 4         | 16         | 18         | 24         |
| <u>+3</u> | <u>+16</u> | <u>+ 1</u> | <u>+ 1</u> |

I was sleeping last night when I heard a bump in the basement.

Star      her      girl      far      tiger

Vowels: \_\_\_\_\_

blast off

Name: \_\_\_\_\_ Date: \_\_\_\_\_

23,202      14      900      813

simple      clock      track      snip

|            |            |           |            |            |
|------------|------------|-----------|------------|------------|
| 11         | 36         | 2         | 14         | 38         |
| <u>+ 1</u> | <u>+ 1</u> | <u>+9</u> | <u>+22</u> | <u>+16</u> |

Hey! You kids! Stop all that noise! Your mother is trying to sleep!

|            |            |            |            |            |
|------------|------------|------------|------------|------------|
| 3          | 3          | 4          | 10         | 0          |
| <u>x 2</u> | <u>x 1</u> | <u>x 2</u> | <u>x 1</u> | <u>x 4</u> |

Vowels: \_\_\_\_\_

blast off

Name: \_\_\_\_\_ Date: \_\_\_\_\_

24,912      16,011      280      301

skunk      creature      light      night

|           |           |            |           |
|-----------|-----------|------------|-----------|
| 2         | 13        | 28         | 8         |
| <u>+7</u> | <u>+1</u> | <u>+19</u> | <u>+2</u> |

All through the night, the goblins and ghosts were acting very scary.

|           |           |            |            |
|-----------|-----------|------------|------------|
| 9         | 6         | 21         | 41         |
| <u>-1</u> | <u>-3</u> | <u>-10</u> | <u>-15</u> |

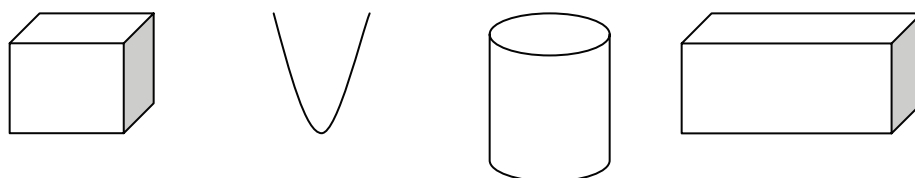
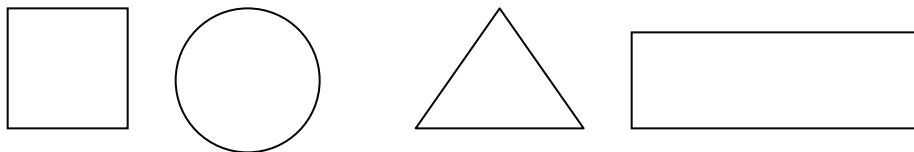

cube

parabola

cylinder

rectangular prism

blast off

Count by 5's

# SPECIAL WORKSHEET

Name: \_\_\_\_\_ Date: \_\_\_\_\_

One-Dimensional Shapes (look like strings):

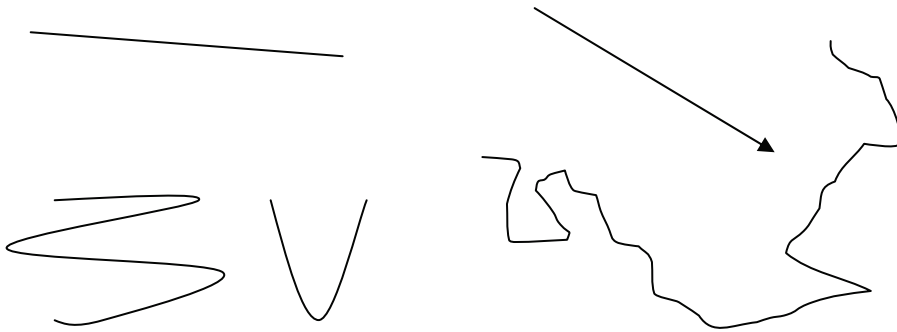

Two-Dimensional Shapes (can paste on wall or color inside):

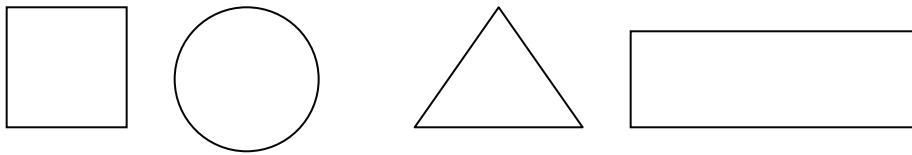

Three-Dimensional Shapes (cannot paste on wall; maybe can hold water):

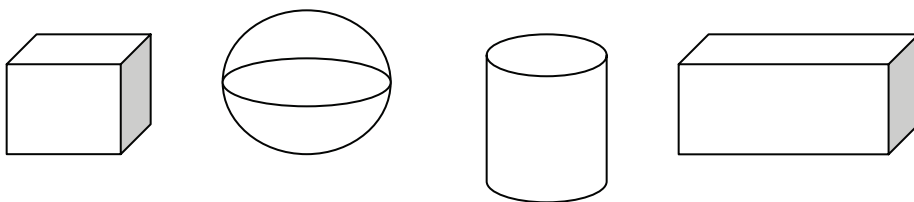

Name: \_\_\_\_\_ Date: \_\_\_\_\_

124,261      80      901      2,000

street      fight      running      tight

26      3      24  
+ 1      +1      +19

When I grow up, I want to be a teacher and a mother.

10      8      26      71  
- 1      -4      - 14      -13

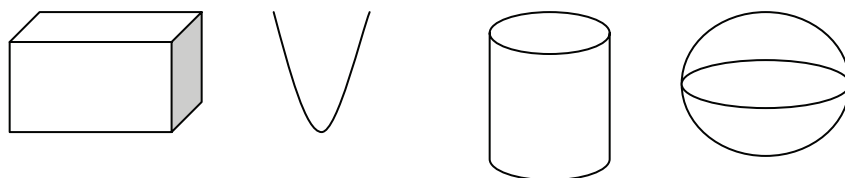
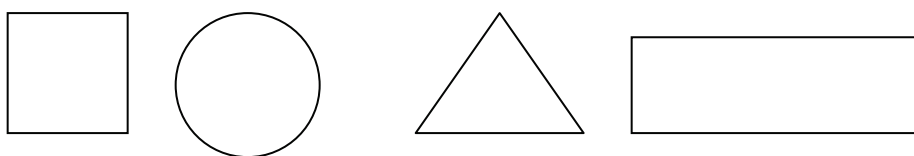

Vowels: \_\_\_\_\_

blast off

Name: \_\_\_\_\_ Date: \_\_\_\_\_

6,402      13      216,391      001

fur   far   fir   for   four   her   girl

217      9      37      4  
+384   +6      + 1   +4

Where will we go? What will we do? Will we be happy? Will they give us a pretzel?

13      2      4      22  
- 9      -1      -2      -14

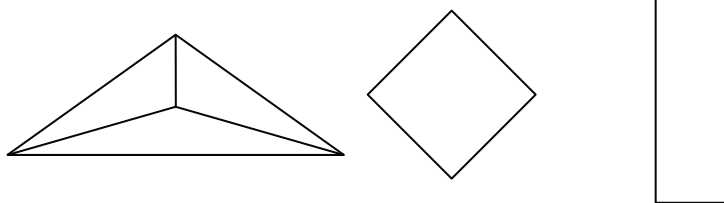
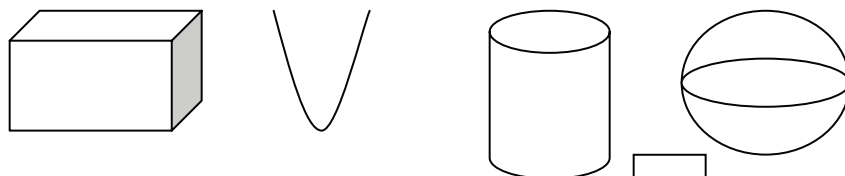
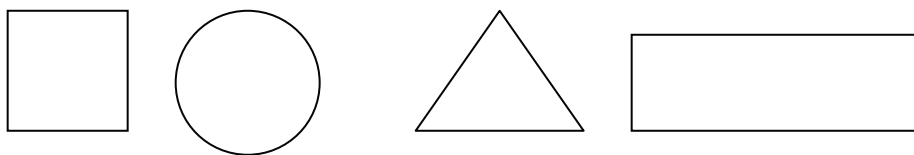

Vowels: \_\_\_\_\_

blast off

Name: \_\_\_\_\_ Date: \_\_\_\_\_

284      12,901      123,600      1,040

fight    sigh    tight    right    high

car      her      turn    girl    fur

46      89      91      3  
- 21    +16    - 34    +9

$3 \cdot 3 = \underline{\quad}$

4      8  
x 2    x 1

$2 \times 5 = \underline{\quad}$

Read a book!

Vowels: \_\_\_\_\_

blast off

Name: \_\_\_\_\_ Date: \_\_\_\_\_

209      60,010      483,216      1,040

castle      whistle      pickle      wrinkle

tire      her      car      four      pair

38      49      91      6      8  
- 14      +86      - 26      +7      -0

$3 \cdot 4 = \underline{\quad}$        $10 \cdot 2 = \underline{\quad}$

$5 \times 3 = \underline{\quad}$        $9 \cdot 2 = \underline{\quad}$

Read a book!

Vowels: \_\_\_\_\_

blast off



Name: \_\_\_\_\_ Date: \_\_\_\_\_

97,401      201,030      390      1,063

Practice “r” words

Addition flash cards

93      28      81      68  
- 41      +37      - 39      +21

$3 \cdot 6 = \underline{\quad}$       23      34  
   x 2      x 2

Read a book!

Vowels: \_\_\_\_\_

blast off

Name: \_\_\_\_\_ Date: \_\_\_\_\_

32,103      111,111      1,000,000      60

right      write      rite      action

### Addition flash cards

91      28      101      286  
- 16      +35      - 86      +395

car      her      red      Kara      girl

Read a book!

Vowels: \_\_\_\_\_

blast off

Name: \_\_\_\_\_ Date: \_\_\_\_\_

29,001      100,010      2,000,311      14

103      2      869      4  
- 64      +5      +348      +5

23      34      12  
x 2      x 2      x 3

Read a book!

Vowels: \_\_\_\_\_

blast off

Name: \_\_\_\_\_ Date: \_\_\_\_\_

2,861,342

200,302

$\frac{2}{3}$

$\frac{3}{7}$

$\frac{1}{4}$

$\frac{1}{2}$

girl her fur car pure fire bear

203  
-126

28  
+14

39  
+21

222  
- 134

25  
x 2

31  
x 3

26  
x 2

43  
x 3

Read a book!

Vowels: \_\_\_\_\_

blast off

Name: \_\_\_\_\_ Date: \_\_\_\_\_

2,163      110,901      431,262      12

hunt      hurt      help      hand

26      9      46      8  
+13      +5      +19      +8

Who says that boys are better? I think girls are better (except for Tommy).

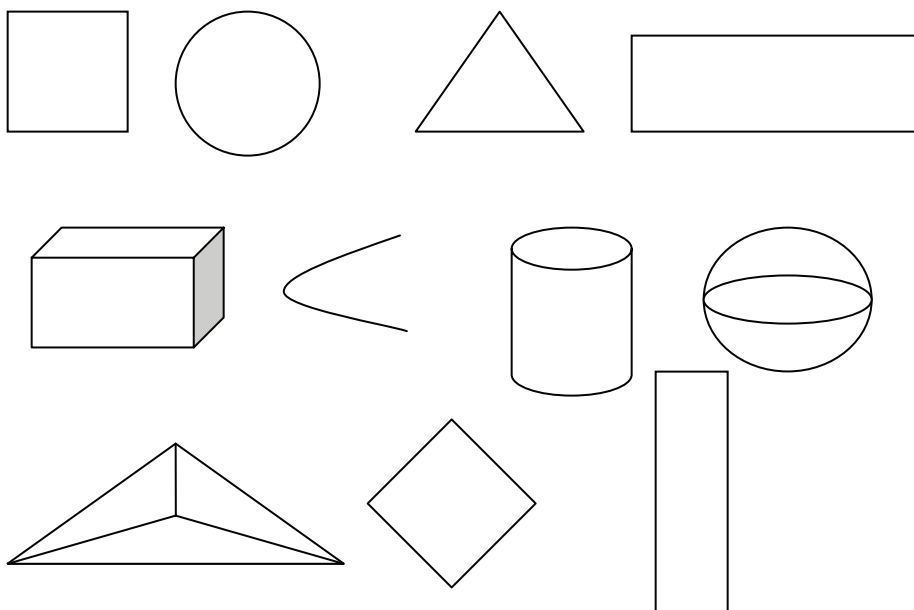

Vowels: \_\_\_\_\_

blast off

Name: \_\_\_\_\_ Date: \_\_\_\_\_

27      912      123,208      401,203

saddle      crunch      chuckle      print

14      27      8      91      18  
- 6      +36      +7      -15      -9

Read a book!

Vowels: \_\_\_\_\_

blast off

Name: \_\_\_\_\_ Date: \_\_\_\_\_

3,603      92,002      179,617      31

cracker      handed      swept      we

6      23      8      81      14  
- 3      +12      +6      - 13      - 5

Read a book!

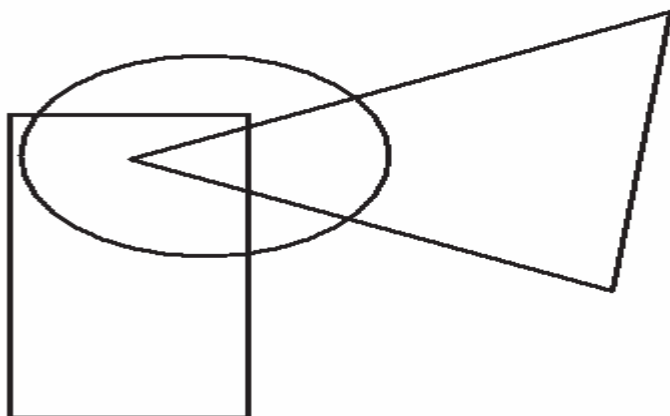

Vowels: \_\_\_\_\_

blast off

Name: \_\_\_\_\_ Date: \_\_\_\_\_

29,020      11,265      10,003

sprinkler    walking    creaky    fox

$$\begin{array}{r} 9 \\ - 3 \\ \hline \end{array}$$

$$\begin{array}{r} 26 \\ + 44 \\ \hline \end{array}$$

$$\begin{array}{r} 8 \\ + 8 \\ \hline \end{array}$$

$$\begin{array}{r} 83 \\ - 15 \\ \hline \end{array}$$

$3 \cdot 2 = \underline{\quad}$        $8 \cdot 2 = \underline{\quad}$

$5 \times 2 = \underline{\quad}$        $7 \cdot 1 = \underline{\quad}$

Read a book!

Line

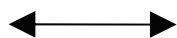

Ray

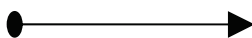

Line Segment

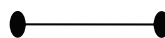

Vowels: \_\_\_\_\_

blast off



Name: \_\_\_\_\_ Date: \_\_\_\_\_

28      2,401      101,001      12

pebble      straw      paste      ankle

    2      26      19      41      6  
- 1      +48      +11      - 14      +8

$2 \cdot 3 = \underline{\quad}$        $4 \cdot 2 = \underline{\quad}$

$3 \times 1 = \underline{\quad}$        $3 \cdot 3 = \underline{\quad}$

Read a book!

Line

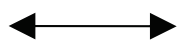

Ray

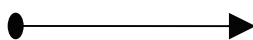

Line Segment

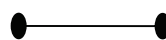

Vowels: \_\_\_\_\_

blast off

Name: \_\_\_\_\_ Date: \_\_\_\_\_

2,600      193,111      47      2/5

strike      clear      proud      smile

7      98      62      18      9  
- 1      +15      - 15      - 6      +8

Read a book!

Line

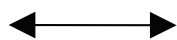

Ray

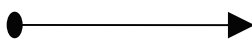

Line Segment

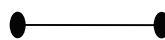

Angles:

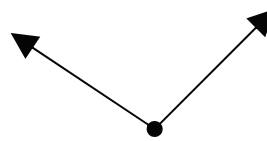
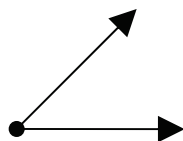

Vowels: \_\_\_\_\_

blast off

Name: \_\_\_\_\_ Date: \_\_\_\_\_

29,666      181,001      430,200

stink      creek      march      giggle

8      19      61      12      4  
- 2      +14      - 13      + 3      +4

$2 \cdot 3 = \underline{\quad}$        $6 \cdot 1 = \underline{\quad}$        $3 \times 3 = \underline{\quad}$

$2 \cdot 5 = \underline{\quad}$        $3 \times 4 = \underline{\quad}$        $8 \cdot 0 = \underline{\quad}$

Read a book!

Angle

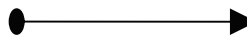

Ray

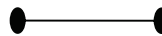

Line Segment

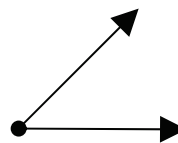

Line

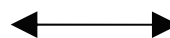

Vowels: \_\_\_\_\_

blast off

Name: \_\_\_\_\_ Date: \_\_\_\_\_

18,029      1,000,000      261,403

gallop      crumble      freckle      peace

though      through      tough      cough      play

$\begin{array}{r} 9 \\ - 3 \\ \hline \end{array}$        $\begin{array}{r} 8 \\ + 8 \\ \hline \end{array}$        $\begin{array}{r} 29 \\ - 13 \\ \hline \end{array}$        $\begin{array}{r} 18 \\ + 19 \\ \hline \end{array}$        $\begin{array}{r} 0 \\ + 4 \\ \hline \end{array}$        $\begin{array}{r} 26 \\ - 17 \\ \hline \end{array}$

$0 \cdot 3 = \underline{\quad}$        $4 \cdot 3 = \underline{\quad}$        $2 \times 3 = \underline{\quad}$

$5 \cdot 3 = \underline{\quad}$        $9 \times 1 = \underline{\quad}$        $10 \cdot 2 = \underline{\quad}$

$8 \cdot 2 = \underline{\quad}$        $1 \cdot 1 = \underline{\quad}$

Read a book!

Vowels: \_\_\_\_\_

blast off

Name: \_\_\_\_\_ Date: \_\_\_\_\_

$$\frac{2}{3} \quad \frac{3}{6} \quad \frac{1}{4} \quad \frac{1}{2} \quad \frac{8}{9} \quad \frac{4}{11}$$

fur      hurt      curl      word      dirt

Read a book!

$$\begin{array}{r} 803 \\ -215 \\ \hline \end{array} \quad \begin{array}{r} 958 \\ +675 \\ \hline \end{array} \quad \frac{1}{2} + \frac{1}{2} = \underline{\hspace{2cm}}$$

$$\frac{2}{3} + \frac{1}{3} = \quad \quad \quad \frac{4}{7} + \frac{6}{7} =$$

$$\begin{array}{r} 23 \\ \times 3 \\ \hline \end{array} \quad \begin{array}{r} 14 \\ \times 2 \\ \hline \end{array} \quad \begin{array}{r} 23 \\ \times 2 \\ \hline \end{array}$$

Vowels: \_\_\_\_\_

blast off

Name: \_\_\_\_\_ Date: \_\_\_\_\_

$$\frac{2}{3} \quad \frac{9}{10} \quad \frac{1}{4} \quad \frac{16}{21} \quad \frac{8}{100} \quad \frac{31}{50}$$

her      curl      burn      car      far      fire

$$\begin{array}{r} 216 \\ - 37 \\ \hline \end{array} \quad \begin{array}{r} 189 \\ + 396 \\ \hline \end{array} \quad \begin{array}{r} 401 \\ - 98 \\ \hline \end{array}$$

$$\frac{2}{2} + \frac{3}{2} = \quad \quad \quad \frac{1}{3} + \frac{2}{3} =$$

$$\begin{array}{r} 24 \\ \times 2 \\ \hline \end{array} \quad \begin{array}{r} 33 \\ \times 3 \\ \hline \end{array} \quad \begin{array}{r} 12 \\ \times 3 \\ \hline \end{array} \quad \begin{array}{r} 15 \\ \times 2 \\ \hline \end{array}$$

Vowels: \_\_\_\_\_

blast off

Name: \_\_\_\_\_ Date: \_\_\_\_\_

$$\frac{2}{3} \quad \frac{3}{20} \quad \frac{1}{4} \quad \frac{1}{2} \quad \frac{4}{7}$$

far      car      care      hurt      girl

$$\begin{array}{r} 328 \\ -149 \\ \hline \end{array} \quad \begin{array}{r} 404 \\ +128 \\ \hline \end{array} \quad \begin{array}{r} 88 \\ +16 \\ \hline \end{array}$$

$$\begin{array}{r} 23 \\ \times 4 \\ \hline \end{array} \quad \begin{array}{r} 25 \\ \times 2 \\ \hline \end{array} \quad \begin{array}{r} 12 \\ \times 3 \\ \hline \end{array} \quad \begin{array}{r} 15 \\ \times 2 \\ \hline \end{array}$$

Read a chapter book!

Vowels: \_\_\_\_\_

blast off

Name: \_\_\_\_\_ Date: \_\_\_\_\_

$$\frac{2}{7} \quad \frac{1}{4} \quad \frac{1}{2}$$

386,429      1,000,021

curve    hurt      girl      her      far

$$\begin{array}{r} 803 \\ -247 \\ \hline \end{array} \quad \begin{array}{r} 968 \\ +347 \\ \hline \end{array} \quad \begin{array}{r} 26 \\ +55 \\ \hline \end{array} \quad \begin{array}{r} 900 \\ -634 \\ \hline \end{array}$$

$$\begin{array}{r} 21 \\ \times 2 \\ \hline \end{array} \quad \begin{array}{r} 35 \\ \times 2 \\ \hline \end{array} \quad \begin{array}{r} 43 \\ \times 3 \\ \hline \end{array} \quad \begin{array}{r} 61 \\ \times 2 \\ \hline \end{array}$$

Read a chapter book!

Vowels: \_\_\_\_\_

blast off



Name: \_\_\_\_\_ Date: \_\_\_\_\_

$$\frac{2}{3} \quad \frac{1}{4} \quad \frac{1}{2}$$

32,068      1,020,010

Read a chapter book!

tire      her      growl      curl      cure

$$\begin{array}{r} 64 \\ - 23 \\ \hline \end{array} \quad \begin{array}{r} 286 \\ + 947 \\ \hline \end{array} \quad \begin{array}{r} 803 \\ - 281 \\ \hline \end{array}$$

$2 \cdot 3 = \underline{\quad}$        $10 \cdot 3 = \underline{\quad}$        $4 \times 3 = \underline{\quad}$

$6 \cdot 2 = \underline{\quad}$        $8 \times 1 = \underline{\quad}$        $10 \cdot 0 = \underline{\quad}$

$$\begin{array}{r} 25 \\ \times 3 \\ \hline \end{array} \quad \begin{array}{r} 78 \\ \times 2 \\ \hline \end{array} \quad \begin{array}{l} 4 \div 2 = \\ 6 \div 2 = \\ 8 \div 2 = \\ 6 \div 1 = \end{array}$$

Vowels: \_\_\_\_\_

blast off

Name: \_\_\_\_\_ Date: \_\_\_\_\_

$$\frac{2}{7} \quad \frac{3}{8} \quad \frac{1}{2}$$

1,063      20,010      1,000,010

curl      world      pure      tire      bore

$$\begin{array}{r} 100 \\ - 21 \\ \hline \end{array} \quad \begin{array}{r} 29 \\ + 84 \\ \hline \end{array} \quad \begin{array}{r} 212 \\ - 34 \\ \hline \end{array}$$

$$\frac{1}{2} + \frac{1}{2} =$$

$$\frac{1}{4} + \frac{3}{4} =$$

$$\frac{1}{2} + \frac{2}{3} =$$

$$\frac{4}{5} + \frac{5}{5} =$$

$$\begin{array}{r} 28 \\ \times 2 \\ \hline \end{array}$$

$$4 \div 2 =$$

$$2 \overline{)6}$$

$$9 \div 3 =$$

$$8 \div 2 =$$

Vowels: \_\_\_\_\_

blast off

Name: \_\_\_\_\_ Date: \_\_\_\_\_

$$\begin{array}{r} \underline{2} \\ 7 \end{array} \quad \begin{array}{r} \underline{9} \\ 31 \end{array}$$

28,604      1,201,310

hard      word      fur      star      fire

Read a chapter book!

$$\begin{array}{r} 401 \\ -246 \\ \hline \end{array} \quad \begin{array}{r} 89 \\ +31 \\ \hline \end{array} \quad \begin{array}{r} 48 \\ -23 \\ \hline \end{array} \quad \begin{array}{r} 877 \\ +928 \\ \hline \end{array}$$

$$\begin{array}{r} 14 \\ \times 3 \\ \hline \end{array} \quad \begin{array}{r} 12 \\ \times 2 \\ \hline \end{array} \quad \begin{array}{l} 2 \times 3 = \\ 4 \times 2 = \end{array} \quad \begin{array}{r} 3 \overline{)6} \\ 8 \div 4 = \end{array}$$

$$\frac{4}{2} = \quad \frac{9}{3} =$$

Vowels: \_\_\_\_\_

blast off

Name: \_\_\_\_\_ Date: \_\_\_\_\_

$$\frac{2}{5} \quad \frac{19}{22}$$

20,030      3,403,062

hard      word      bird      clobber

Read a chapter book!

$$\frac{2}{3} + \frac{3}{3} =$$

$$\frac{1}{4} + \frac{2}{5} =$$

$$\begin{array}{r} 213 \\ -184 \\ \hline \end{array} \quad \begin{array}{r} 396 \\ +148 \\ \hline \end{array}$$

$$\begin{array}{r} 15 \\ \times 3 \\ \hline \end{array} \quad \begin{array}{r} 12 \\ \times 3 \\ \hline \end{array} \quad 2 \overline{)10} \quad 4 \overline{)8}$$

Vowels: \_\_\_\_\_

blast off

Name: \_\_\_\_\_ Date: \_\_\_\_\_

$$\begin{array}{r} \underline{2} \quad \underline{31} \\ 9 \quad 43 \end{array}$$

18,603      2,000,201      156  
harbor      cranium      cradle      crater

Read a chapter book!

$$\begin{array}{r} 203 \\ - 67 \\ \hline \end{array} \quad \begin{array}{r} 28 \\ + 36 \\ \hline \end{array} \quad \begin{array}{r} 48 \\ - 19 \\ \hline \end{array} \quad \begin{array}{r} 19 \\ + 4 \\ \hline \end{array} \quad \begin{array}{r} 2 \\ + 8 \\ \hline \end{array}$$

$$\begin{array}{r} 15 \\ \times 4 \\ \hline \end{array} \quad \begin{array}{r} 12 \\ \times 4 \\ \hline \end{array} \quad \begin{array}{l} 2 \cdot 3 = \\ 4 \times 5 = \\ 6 \times 2 = \end{array} \quad \begin{array}{r} 9 \overline{)18} \\ 6 \div 3 = \\ \frac{12}{6} = \end{array}$$

Vowels: \_\_\_\_\_

blast off

Name: \_\_\_\_\_ Date: \_\_\_\_\_

$$\begin{array}{r} \underline{2} \\ 8 \end{array} \quad \begin{array}{r} \underline{3} \\ 9 \end{array}$$

1,021,964      28,032

harp      crude      pure      try      iron

Read a chapter book!

$$\begin{array}{r} 603 \\ -214 \\ \hline \end{array} \quad \begin{array}{r} 25 \\ +38 \\ \hline \end{array} \quad \begin{array}{r} 213 \\ -87 \\ \hline \end{array} \quad \begin{array}{r} 286 \\ +965 \\ \hline \end{array}$$

$$6 \overline{)12} \quad 9 \div 3 = \quad 8 \div 2 =$$

$$\begin{array}{r} 37 \\ \times 3 \\ \hline \end{array} \quad \begin{array}{r} 14 \\ \times 2 \\ \hline \end{array} \quad \begin{array}{r} 8 \\ \times 2 \\ \hline \end{array} \quad \begin{array}{r} 15 \\ \times 3 \\ \hline \end{array}$$

Vowels: \_\_\_\_\_

blast off

Name: \_\_\_\_\_ Date: \_\_\_\_\_

$$\frac{3}{4} \quad \frac{1}{2} \quad \frac{9}{10}$$

2,001          1,092,612

cart          strap          pearl          lurk          brick

$$\begin{array}{r} 43 \\ -21 \\ \hline \end{array} \quad \begin{array}{r} 29 \\ +68 \\ \hline \end{array} \quad \begin{array}{r} 213 \\ -87 \\ \hline \end{array} \quad \begin{array}{r} 987 \\ +346 \\ \hline \end{array}$$

$$2 \overline{)6} \quad 8 \div 2 =$$

$$\frac{9}{3} = \quad \frac{12}{6} =$$

$$\begin{array}{r} 9 \\ \times 3 \\ \hline \end{array} \quad \begin{array}{r} 29 \\ \times 3 \\ \hline \end{array} \quad \begin{array}{r} 30 \\ \times 3 \\ \hline \end{array} \quad \begin{array}{r} 24 \\ \times 12 \\ \hline \end{array}$$

Vowels: \_\_\_\_\_

blast off

Name: \_\_\_\_\_ Date: \_\_\_\_\_

$$\begin{array}{r} \underline{1} \\ 4 \end{array} \quad \begin{array}{r} \underline{1} \\ 2 \end{array} \quad \begin{array}{r} \underline{31} \\ 32 \end{array}$$

2,863,902      24,603

$$\begin{array}{r} 603 \\ -124 \\ \hline \end{array} \quad \begin{array}{r} 213 \\ -47 \\ \hline \end{array} \quad \begin{array}{r} 897 \\ +689 \\ \hline \end{array}$$

$$2 \overline{)4} \quad 1 \overline{)8} \quad 3 \overline{)0} \quad 6 \div 2 =$$

$$\frac{9}{3} = \quad \frac{8}{4} = \quad \frac{4}{2} =$$

$$\begin{array}{r} 31 \\ \times 12 \\ \hline \end{array} \quad \begin{array}{r} 28 \\ \times 2 \\ \hline \end{array} \quad \begin{array}{r} 35 \\ \times 3 \\ \hline \end{array} \quad \begin{array}{r} 24 \\ \times 13 \\ \hline \end{array}$$

Read Chapter Book!

Vowels: \_\_\_\_\_

blast off



Name: \_\_\_\_\_ Date: \_\_\_\_\_

$$\begin{array}{r} \underline{1} \\ 2 \end{array} \quad \begin{array}{r} \underline{23} \\ 43 \end{array}$$

1,091,063      48

car      her      fur      cure      puree      fewer

$$\begin{array}{r} 903 \\ \underline{-421} \end{array} \quad \begin{array}{r} 812 \\ \underline{-629} \end{array} \quad \begin{array}{r} 189 \\ \underline{+286} \end{array}$$

$$4 \overline{)12} \quad 4 \overline{)16} \quad 3 \overline{)12} \quad 2 \overline{)10}$$

$$\begin{array}{r} 29 \\ \underline{\times 12} \end{array} \quad \begin{array}{r} 38 \\ \underline{\times 3} \end{array} \quad 2 \cdot 6 = \underline{\quad}$$

$$\frac{1}{2} + \frac{3}{2} =$$

Vowels: \_\_\_\_\_

blast off